

ACB / MCCB / ELCB / ATS MCB / SPD / MS / MMS



Index

A. MCCB/ EMCCB/ ELCB / MCB	P02
B. ATS (MCCB TYPE 、 MS TYPE)	P22
C. ACB	P23
D. MCB/ RCBO	P24
E. SPD / TVSS	P26
F. MS	P27
G. MMS	P44

Index

MCCB
ELCB

ATS

ACB





MCB

SPD

MS





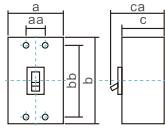

MMS

Molded Case Circuit Breaker

Frame size (AF) (Inm)		30		50		60								
Type		BM30-CN		BM30-SN		BM50-CN		BM60-SN		BM60-HN				
Appearance														
Rated current In (A) at ambient temp. 40°C		3, 5, 10, 15, 20, 30.		3, 5, 10, 15, 20, 30.		10, 15, 20, 30, 40, 50.		10, 15, 20, 25, 30, 40, 50, 60.		10, 15, 20, 25, 30, 40, 50, 60.				
Number of poles (P)		2	3	2	3	2	3	2	3	4	2	3	4	
Rated insulation voltage Ui (V)		AC		690		690		690		690		690		
		DC		—		—		—		—		—		
Dimensions		a	45	67.5	50	75	50	75	50	75	100	50	75	100
		b	96		130		130		130		130		130	
		c	52		68		68		68		68		68	
		ca	67		90		90		90		90		90	
		bb	84		111		111		111		111		111	
		aa	23.5		25		25		25		25		25	
Weight (kg)		0.3	0.4	0.45	0.65	0.45	0.65	0.45	0.65	0.85	0.45	0.65	0.85	
Rated breaking capacity (kA)	IEC 60947-2 EN 60947-2 AC	500V	—		1.5		1.5		5		5			
		440V	—		2.5		2.5		7.5		10			
		380V	1.5		2.5		2.5		7.5		15			
		220V(240V)	2.5		5		5		10		25			
	DC	250V	—		—		—		—		—			
		125V	—		—		—		—		—			
Connection		Clamp terminal		Clamp terminal		Clamp terminal		Clamp terminal		Clamp terminal				
Optional accessories	Alarm switch (AL)	—		○		○		○		○				
	Auxiliary switch (AX)	—		○		○		○		○				
	Shunt trip (SHT)	—		○		○		○		○				
	Under-voltage trip (UVT)	—		○		○		○		○				
	External handle (EH)	—		●		●		●		●				
	Terminal cover (TC)	●		●		●		●		●				
Trip Unit		Hydraulic magnetic		Hydraulic magnetic		Hydraulic magnetic		Hydraulic magnetic		Hydraulic magnetic				
Tripping button		—		Equipped		Equipped		Equipped		Equipped				

Note 1. "●" which can be installed by client, "○" which have to be installed by manufacturer. "—" which is not available.
 Above accessories table is for 3P breaker.
 2. Ics= 50% Icu
 3. Adjustable thermal: 80%~100% In.

80% ~ 100% Adj. (A)

60	100										
BM60-HBN	BM100-MN		BM100-SN		BM100-HN			BM100-HBN		BM100-H	
											
10, 15, 20, 30, 40, 50, 60.	10, 15, 20, 30, 40, 50, 60, 75, 100.		10, 15, 20, 30, 40, 50, 60, 75, 100.		10, 15, 20, 30, 40, 50, 60, 75, 100.			40, 50, 63, 80, 100.		15, 20, 30, 40, 50, 60, 75, 100.	
3	2	3	2	3	2	3	4	3	4	3	4
690	690		690		690			690		690	
—	—		—		—			—		—	
90	50	75	50	75	60	90	120	105	140	105	140
155	130		130		155			165		165	
68	68		68		68			68		86	
90	90		90		90			92		112	
132	111		111		132			126		126	
30	25		25		30			35		35	
1.3	0.45	0.65	0.45	0.65	0.9	1.3	1.6	1.5	1.9	2.1	2.6
15	5		5		15			20		25	
25	7.5		10		25			32		42	
30	10		15		30			36		50	
50	15		25		50			85		85	
—	—		—		—			—		—	
—	—		—		—			—		—	
Clamp terminal	Clamp terminal		Clamp terminal		Clamp terminal			Clamp terminal		Clamp terminal	
○	○	○	○	○	○	○	○	●	○	○	○
○	○	○	○	○	○	○	○	●	○	○	○
○	○	○	○	○	○	○	○	●	○	○	○
○	○	○	○	○	○	○	○	●	○	○	—
●	●	●	●	●	●	●	●	●	●	●	●
●	●	●	●	●	●	●	●	●	●	●	●
Hydraulic magnetic	Hydraulic magnetic		Hydraulic magnetic		Hydraulic magnetic			Adj. thermal Fixed magnetic		Thermal magnetic	
Equipped	Equipped		Equipped		Equipped			Equipped		Equipped	

Index

MCCB
ELCB

ATS

ACB

MCB





SPD

MS

MMS

Molded Case Circuit Breaker



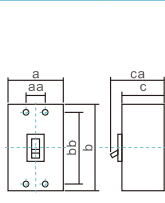



80% ~ 100% Adj. (A)

Frame size (AF) (Inm)		100				125			160							
Type		BM100-HC		BM100-HS		BM125-SN			BM125-HN			BM160-SN				
Appearance																
Rated current In (A) at ambient temp. 40°C		40, 50, 63, 80, 100.		40, 50, 63, 80, 100.		10, 15, 20, 30, 40, 50, 60, 75, 100, 125.			10, 15, 20, 30, 40, 50, 60, 75, 100, 125.			125, 140, 160.				
Number of poles (P)		3	4	3	4	2	3	4	2	3	4	2	3	4		
Rated insulation voltage Ui (V)		AC		690		690			690			690				
		DC		—		—			—			—				
Dimensions		a	105	140	105	140	60	90	120	60	90	120	105	105	140	
		b	165		165		155			155			165			
		c	86		86		68			68			68			
		ca	112		112		90			90			92			
		bb	126		126		132			132			126			
		aa	35		35		30			30			35			
Weight (kg)		2.1	2.6	2.1	2.6	0	30	30	0	30	30	1.3	1.5	1.9		
Rated breaking capacity (kA)	IEC 60947-2 EN 60947-2 Icu	AC	500V	42		50		7.5			15			15		
			440V	55		70		15			25			25		
			380V	70		85		22			30			30		
			220V(240V)	100		125		30			50			50		
	DC	250V	—		—		—			—			—			
		125V	—		—		—			—			—			
Connection		Clamp terminal		Clamp terminal		Clamp terminal			Clamp terminal			Clamp terminal				
Optional accessories	Alarm switch (AL)	○		○		○			○			●				
	Auxiliary switch (AX)	○		○		○			○			●				
	Shunt trip (SHT)	○		○		○			○			●				
	Under-voltage trip (UVT)	—		—		— ○ ○			— ○ ○			●				
	External handle (EH)	●		●		●			●			●				
	Terminal cover (TC)	●		●		●			●			●				
Trip Unit		Thermal magnetic		Thermal magnetic		Hydraulic magnetic			Hydraulic magnetic			Adj. thermal Fixed magnetic				
Tripping button		Equipped		Equipped		Equipped			Equipped			Equipped				

Note 1. "●" which can be installed by client, "○" which have to be installed by manufacturer. "—" which is not available.
 Above accessories table is for 3P breaker.
 2. Ics= 50% Icu
 3. Adjustable thermal: 80%~100% In.





80% ~ 100% Adj. (A)

80% ~ 100% Adj. (A)



160				250								
BM160-HN		BM160-HB		BM160-HC		BM160-HS		BM250-CN			BM250-SN	
												
125, 140, 160.		125, 140, 160.		125, 140, 160.		125, 140, 160.		125, 150, 175, 200, 225, 250.			125, 150, 175, 200, 225, 250.	
3	4	3	4	3	4	3	4	2	3	4	3	4
690		690		690		690		690			690	
—		—		—		—		250	—	—	—	
105	140	105	140	105	140	105	140	105	105	140	105	140
165		165		165		165		165			165	
68		86		86		86		68			68	
92		112		112		112		92			92	
126		126		126		126		126			126	
35		35		35		35		35			35	
1.5	1.9	2.1	2.6	2.1	2.6	2.1	2.6	1.3	1.5	1.9	1.5	1.9
20		25		42		50		7.5			15	
32		42		55		70		15			25	
36		50		70		85		22			30	
85		85		100		125		30			50	
—		—		—		—		10	—	—	—	
—		—		—		—		15	—	—	—	
Clamp terminal		Clamp terminal		Clamp terminal		Clamp terminal		Clamp terminal			Clamp terminal	
●		○		○		○		●			●	
●		○		○		○		●			●	
●		○		○		○		●			●	
●		—		—		—		●			●	
●		●		●		●		●			●	
●		●		●		●		●			●	
Adj. thermal Fixed magnetic		Thermal magnetic		Thermal magnetic		Thermal magnetic		Adj. thermal Fixed magnetic			Adj. thermal Fixed magnetic	
Equipped		Equipped		Equipped		Equipped		Equipped			Equipped	

Molded Case Circuit Breaker

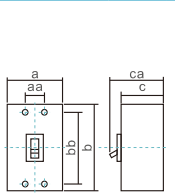
80% ~ 100% Adj. (A)

Frame size (AF) (Inm)		250						400					
Type		BM250-HN		BM250-HB		BM250-HC		BM250-HS		BM400-CN			
Appearance													
Rated current In (A) at ambient temp. 40°C		175, 200, 225, 250.		100, 125, 150, 160, 175, 200, 225, 250.		175, 200, 225, 250.		175, 200, 225, 250.		250, 300, 350, 400.			
Number of poles (P)		3	4	3	4	3	4	3	4	2	3	4	
Rated insulation voltage Ui (V)		AC		690		690		690		690			
		DC		—		—		—		250		—	—
Dimensions		a	105	140	105	140	105	140	105	140	140	140	185
		b	165		165		165		165		257		
		c	68		86		86		86		103		
		ca	92		112		112		112		155		
		bb	126		126		126		126		194		
		aa	35		35		35		35		44		
		(mm)											
Weight (kg)		1.5	1.9	2.1	2.6	2.1	2.6	2.1	2.6	5.0	5.7	7.5	
Rated breaking capacity (kA)	IEC 60947-2 EN 60947-2 AC	500V	20		25		42		50		14		
		440V	32		42		55		70		22		
		380V	36		50		70		85		25		
		220V(240V)	85		85		100		125		35		
	DC	250V	—		—		—		—		10	—	—
		125V	—		—		—		—		15	—	—
Connection		Clamp terminal		Clamp terminal		Clamp terminal		Clamp terminal		Busbar			
Optional accessories	Alarm switch (AL)	●		○		○		○		●			
	Auxiliary switch (AX)	●		○		○		○		●			
	Shunt trip (SHT)	●		○		○		○		●			
	Under-voltage trip (UVT)	●		—		—		—		●			
	External handle (EH)	●		●		●		●		●			
	Terminal cover (TC)	●		●		●		●		●			
Trip Unit		Adj. thermal Fixed magnetic		Thermal magnetic		Thermal magnetic		Thermal magnetic		Thermal magnetic			
Tripping button		Equipped		Equipped		Equipped		Equipped		Equipped			

Note 1. "●" which can be installed by client, "○" which have to be installed by manufacturer. "—" which is not available.
 Above accessories table is for 3P breaker.
 2. Ics= 50% Icu
 3. Adjustable thermal: 80%~100% In.

400				630							
BM400-SN		BM400-HN		BM400-RN		BM400-UN		BM630-CN		BM630-SN	
											
250, 300, 350, 400.		250, 300, 350, 400.		250, 300, 350, 400.		250, 300, 350, 400.		500, 600, 630.		500, 630.	
3	4	3	4	3	4	3	4	3	3	4	4
690		690		690		690		690		690	
—		—		—		—		250		250	
140	185	140	185	140	185	140	185	210	210	280	—
257		257		257		257		275		275	
103		103		103		103		103		103	
155		155		155		155		155		155	
194		194		194		194		243		243	
44		44		44		44		70		70	
5.7	7.5	5.7	7.5	5.7	7.5	5.7	7.5	10	10	13	—
20		25		42		65		14		20	
30		42		55		85		22		30	
35		50		70		85		25		35	
50		85		100		125		35		50	
—		—		—		—		10		20	
—		—		—		—		—		—	
Busbar		Busbar		Busbar		Busbar		Busbar		Busbar	
●	●	●	●	●	●	●	●	●	●	●	●
●	●	●	●	●	●	●	●	●	●	●	●
●	●	●	●	●	●	●	●	●	●	●	●
●	●	●	●	●	●	●	●	●	●	●	●
●	●	●	●	●	●	●	●	●	●	●	●
●	●	●	●	●	●	●	●	●	●	●	●
Thermal magnetic		Thermal magnetic		Thermal magnetic		Thermal magnetic		Fixed thermal Adj. magnetic		Fixed thermal Adj. magnetic	
Equipped		Equipped		Equipped		Equipped		Equipped		Equipped	

Index

MCCB
ELCB

ATS

ACB





MCB

SPD



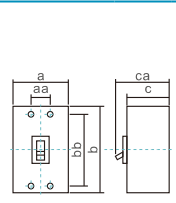

MS

MMS

Molded Case Circuit Breaker

Frame size (AF) (Inm)		630				800							
Type		BM630-HN		BM630-RN		BM630-UN		BM800-CN		BM800-SN			
Appearance													
Rated current In (A) at ambient temp. 40°C		500, 630.		500, 630.		500, 630.		700, 800.		700, 800.			
Number of poles (P)		3	4	3	4	3	4	3	4	3	4		
Rated insulation voltage Ui (V)		AC		690		690		690		690			
		DC		250	—	—	—	250	—	250	—		
 Dimensions (mm)		a	210	280	210	280	210	280	210	280	210	280	
		b	275		275		275		275		275		
		c	103		103		103		103		103		
		ca	155		155		155		155		155		
		bb	243		243		243		243		243		
		aa	70		70		70		70		70		
Weight (kg)		10	13	10	13	10	13	10.5	13.5	10.5	13.5		
Rated breaking capacity (kA)		IEC 60947-2 EN 60947-2 AC	500V	25		42		65		20		25	
			440V	50		70		85		30		50	
			380V	50		70		100		35		50	
			220V(240V)	85		100		125		50		85	
		DC	250V	40	—	—	—	—	20	—	40	—	
			125V	—		—		—		—		—	
Connection		Busbar		Busbar		Busbar		Busbar		Busbar			
Optional accessories		Alarm switch (AL)	●		●		●		●		●		
		Auxiliary switch (AX)	●		●		●		●		●		
		Shunt trip (SHT)	●		●		●		●		●		
		Under-voltage trip (UVT)	●		●		●		●		●		
		External handle (EH)	●		●		●		●		●		
		Terminal cover (TC)	●		●		●		●		●		
Trip Unit		Fixed thermal Adj. magnetic		Fixed thermal Adj. magnetic		Fixed thermal Adj. magnetic		Fixed thermal Adj. magnetic		Fixed thermal Adj. magnetic			
Tripping button		Equipped		Equipped		Equipped		Equipped		Equipped			

Note 1 "●" which can be installed by client, "○" which have to be installed by manufacturer. "—" which is not available.
 Above accessories table is for 3P breaker.
 2. Ics= 50% Icu

800		1000		1200		1600			
BM800-HN		BM800-RN		BM1000-HS		BM1200-HS		BM1600-HS	
									
700, 800.		700, 800.		1000		1200		1400, 1600.	
3	4	3	4	3	3	3	3	3	3
690		690		690		690		690	
—		—		—		—		—	
210	280	210	280	210	210	210	210	210	210
275		275		406		406		406	
103		103		140		140		140	
155		155		190		190		190	
243		243		375		375		375	
70		70		70		70		70	
10.5	13.5	10.5	13.5	23	23	23	23	23	23
42		65		65		65		65	
70		85		85		85		85	
70		100		100		100		100	
100		125		130		130		130	
—		—		—		—		—	
—		—		—		—		—	
Busbar		Busbar		Busbar		Busbar		Busbar	
●		●		○		○		○	
●		●		○		○		○	
●		●		○		○		○	
●		●		○		○		○	
●		●		—		—		—	
●		●		—		—		—	
Fixed thermal Adj. magnetic		Fixed thermal Adj. magnetic		Fixed thermal Adj. magnetic		Fixed thermal Adj. magnetic		Fixed thermal Adj. magnetic	
Equipped		Equipped		Equipped		Equipped		Equipped	

Index

MCCB
ELCB

ATS

ACB

MCB

SPD

MS

MMS



Molded Case Circuit Breaker (Electronic trip Unit)

Frame size (AF) (Inm)		100			160			250			
Type		BM100-HE	BM100-RE	BM100-UE	BM160-HE	BM160-RE	BM160-UE	BM250-HE	BM250-RE	BM250-UE	
Rated current In (A) at ambient temp. 40°C		100			160			250			
Electronically adjustable current Ir (A)		40, 45, 50, 60, 70, 80, 90, 95, 100.			64, 72, 80, 96, 112, 128, 144, 152, 160.			100, 113, 125, 150, 175, 200, 225, 238, 250.			
Rated operational voltage Ue (V)		400			400			400			
Rated insulation voltage Ui (V)		690			690			690			
Rated impulse withstand voltage Uimp (V)		8000			8000			8000			
Number of poles (P)		3P / 4P			3P / 4P			3P / 4P			
Model		HE	RE	UE	HE	RE	UE	HE	RE	UE	
Rated breaking capacity Icu (kA)		50	70	85	50	70	85	50	70	85	
Dimensions (mm)	<p>(mm)</p>	a	105 / 140			105 / 140			105 / 140		
		b	165			165			165		
		c	86			86			86		
		ca	112			112			112		
		bb	126			126			126		
		aa	35			35			35		
Weight (kg)		2.5 / 3.0			2.5 / 3.0			2.5 / 3.0			
Endurance	Electrical life (10 thousand)	1,000			1,000			1,000			
	Mechanical life (10 thousand)	8,500			7,000			7,000			
Connection		Clamp terminal			Clamp terminal			Clamp terminal			
Trip unit		Electronic			Electronic			Electronic			
Trip button		Equipped			Equipped			Equipped			
Optional accessories	Alarm switch (AL)	○			○			○			
	Auxiliary switch (AX)	○			○			○			
	Shunt trip (SHT)	○			○			○			
	Under-voltage trip (UVT)	—			—			—			
	Lead wiring terminal (LT)	○			○			○			
	Motor operation device	○			○			○			
	Communication (COM)	○			○			○			
	Communication (HUB)	○			○			○			

Note 1. Ics= 50% Icu

400			630			800			1000		1250	
BM400-HE	BM400-RE	BM400-UE	BM630-HE	BM630-RE	BM630-UE	BM800-SE	BM800-HE	BM800-RE	BM1000-SE	BM1000-HE	BM1250-SE	BM1250-HE
400			630			800			1000		1250	
160, 180, 200, 240, 280, 320, 360, 380, 400.			252, 284, 315, 378, 441, 504, 567, 600, 630.			320, 360, 400, 480, 560, 640, 720, 760, 800.			400, 450, 500, 600, 700, 800, 900, 950, 1000.		500, 563, 625, 750, 875, 1000, 1125, 1188, 1250.	
400			400			400			400		400	
690			690			690			690		690	
8000			8000			8000			8000		8000	
3P / 4P			3P / 4P			3P / 4P			3P		3P	
HE	RE	UE	HE	RE	UE	SE	HE	RE	SE	HE	SE	HE
50	70	85	50	70	85	50	70	85	70	85	70	85
140 / 185			210 / 280			210 / 280			210		210	
257			275			275			406		406	
103			103			103			140		140	
144			155			155			190		190	
194			243			243			375		375	
44			70			70			70		70	
7 / 8			11.5 / 14.5			11.5 / 14.5			26		26	
1, 000			1, 000			500			500		500	
4, 000			4, 000			2, 500			2, 500		2, 500	
Busbar			Busbar			Busbar			Busbar		Busbar	
Electronic			Electronic			Electronic			Electronic		Electronic	
Equipped			Equipped			Equipped			Equipped		Equipped	
○			○			○			—		—	
○			○			○			—		—	
○			○			○			—		—	
○			○			○			—		—	
—			—			—			—		—	
○			○			○			—		—	
○			○			○			—		—	
○			○			○			—		—	

Index

MCCB
ELCB

ATS

ACB



MCB

SPD

MS



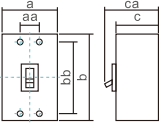

MMS

Earth Leakage Circuit Breaker

Frame size (AF) (Inm)		50		100				
Type		BL50-SN		BL100-SN		BL100-HN		
Appearance								
Rated current In (A) at ambient temp. 40°C		15, 20, 30, 40, 50.		15, 20, 30, 40, 50, 60, 75, 100.		15, 20, 30, 40, 50, 60, 75, 100.		
Phase & wire (P)		1ø2W, 3ø3W.	3ø4W	1ø2W, 3ø3W.	3ø4W	1ø2W, 3ø3W.	3ø4W	
Number of poles (P)		3	4	3	4	3	4	
Rated voltage (VAC)		230, 400.		230, 400.		230, 400.		
High speed	Rated current sensitivity IΔn (mA)	30, 100, 300, 500 (Note 2)		30, 100, 300, 500 (Note 2)		30, 100, 300, 500 (Note 2)		
	5IΔn operating time (S)	0.04		0.04		0.04		
Delay	Rated current sensitivity IΔn (mA)	100- 300- 500 adjustable		100- 300- 500 adjustable		100- 300- 500 adjustable		
	2IΔn operating time (S)	0.1- 0.4- 0.8- 2.0 adjustable		0.1- 0.4- 0.8- 2.0 adjustable		0.1- 0.4- 0.8- 2.0 adjustable		
	2IΔn max. non-operating time (S)	0, 0.2, 0.4, 1.0		0, 0.2, 0.4, 1.0		0, 0.2, 0.4, 1.0		
	Leakage detection mode	Mechanical push-button		Mechanical push-button		Mechanical push-button		
Dimensions	 (mm)	a	75	100	90	120	90	120
		b	130		155		155	
		c	68		68		68	
		ca	90		90		90	
		bb	111		132		132	
		aa	25		30		30	
Weight (kg)		0.7	0.9	1.5	1.8	1.5	1.8	
SPD	Rated breaking capacity (kA)	AC	IEC 60947-2 EN 60947-2 CNS 14816-2	440V	7.5	10	25	
				380V	7.5	15	30	
			Icu	220V	10	25	50	
Connection		Clamp terminal		Clamp terminal		Clamp terminal		
Optional accessories	Alarm switch (AL)	○		○		○		
	Auxiliary switch (AX)	○		○		○		
	Shunt trip (SHT)	○		○		○		
	Under-voltage trip (UVT)	—		○		○		
	External handle (EH)	●		●		●		
	Terminal cover (TC)	●		●		●		
	Leakage alarm module (AM)	—		○		○		
Trip Unit		Hydraulic magnetic		Hydraulic magnetic		Hydraulic magnetic		
Tripping button		Equipped		Equipped		Equipped		

- Note
1. "●" which can be installed by client, "○" which have to be installed by manufacturer. "—" which is not available.
 2. Specify rated current sensitivity when place the order.
 3. Ics= 50% Icu
 4. Adjustable thermal: 80%~100% In.
 5. Specify, when order delay type rated current sensitivity 30-100-500mA.

80% ~ 100% Adj. (A)

160		250		400			
BL160-SN		BL250-SN		BL400-SN	BL400-HN	BL400-RN	
							
125, 140, 160.		175, 200, 225, 250.		250, 300, 350, 400.		250, 300, 350, 400.	
1ø2W, 3ø3W.	3ø4W	1ø2W, 3ø3W.	3ø4W	1ø2W, 3ø3W.	3ø4W	1ø2W, 3ø3W.	3ø4W
3	4	3	4	3	4	3	4
230, 400.		230, 400.		230, 400.		230, 400.	
30, 100-300-500 Adj.		30- 100- 500 adjustable		30- 100- 500 adjustable		30- 100- 500 adjustable	
0.04		0.04		0.04		0.04	
100- 300- 500 adjustable		100- 300- 500 adjustable		100- 300- 500 adjustable		100- 300- 500 adjustable	
0.1- 0.4- 0.8- 2.0 adjustable		0.1- 0.4- 0.8- 2.0 adjustable		0.1- 0.4- 0.8- 2.0 adjustable		0.1- 0.4- 0.8- 2.0 adjustable	
0, 0.2, 0.4, 1.0		0, 0.2, 0.4, 1.0		0, 0.2, 0.4, 1.0		0, 0.2, 0.4, 1.0	
Mechanical push-button		Mechanical push-button		Mechanical push-button		Mechanical push-button	
105	140	105	140	140	185	140	185
165		165		257		257	
68		68		103		103	
92		92		155		155	
126		126		194		194	
35		35		44		44	
1.7	2.3	1.7	2.3	6.6	8.4	6.6	8.4
25		25		30		42	
30		30		35		50	
50		50		50		85	
Clamp terminal		Clamp terminal		Busbar		Busbar	
●		●		●		●	
●		●		●		●	
●		●		●		●	
●		●		●		●	
●		●		●		●	
●		●		●		●	
○		○		○		○	
Adj. thermal Fixed magnetic		Adj. thermal Fixed magnetic		Thermal magnetic		Thermal magnetic	
Equipped		Equipped		Equipped		Equipped	

Index

MCCB
ELCB

ATS

ACB



MCB

SPD



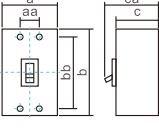

MS

MMS

Earth Leakage Circuit Breaker

Frame size (AF) (Inm)		400		630				
Type		BL400-UN		BL630-HN		BL630-RN		
Appearance								
Rated current In (A) at ambient temp. 40°C		250, 300, 350, 400.		500, 630.		500, 630.		
Phase & wire (P)		1ø2W, 3ø3W.	3ø4W	1ø2W, 3ø3W.	3ø4W	1ø2W, 3ø3W.	3ø4W	
Number of poles (P)		3	4	3	4	3	4	
Rated voltage (VAC)		230, 400.		230, 400.		230, 400.		
High speed	Rated current sensitivity IΔn (mA)	30- 100- 500 adjustable		100- 300- 500 adjustable		100- 300- 500 adjustable		
	5IΔn operating time (S)	0.04		0.04		0.04		
Delay	Rated current sensitivity IΔn (mA)	100- 300- 500 adjustable		100- 300- 500 adjustable		100- 300- 500 adjustable		
	2IΔn operating time (S)	0.45- 1.0- 2.0 adjustable		0.45- 1.0- 2.0 adjustable		0.45- 1.0- 2.0 adjustable		
	2IΔn max. non-operating time (S)	0.1, 0.5, 1.0		0.1, 0.5, 1.0		0.1, 0.5, 1.0		
	Leakage detection mode	Mechanical push-button		Mechanical push-button		Mechanical push-button		
Dimensions	 (mm)	a	140	185	210	280	210	280
		b	257		257		257	
		c	103		103		103	
		ca	155		155		155	
		bb	194		243		243	
		aa	44		70		70	
Weight (kg)		5.7	7.5	10.0	13.0	10.0	13.0	
SPD	Rated breaking capacity (kA)	AC	IEC 60947-2	440V	85	50	70	
			EN 60947-2	380V	85	50	70	
			CNS 14816-2	220V	125	85	100	
MS	Optional accessories	Connection		Busbar		Busbar		
		Alarm switch (AL)	●	●	●			
		Auxiliary switch (AX)	●	●	●			
		Shunt trip (SHT)	●	●	●			
		Under-voltage trip (UVT)	●	●	●			
		External handle (EH)	●	●	●			
		Terminal cover (TC)	●	●	●			
		Leakage alarm module (AM)	○	○	○			
Trip Unit		Thermal magnetic		Fixed thermal Adj. magnetic		Fixed thermal Adj. magnetic		
Tripping button		Equipped		Equipped		Equipped		

- Note
1. "●" which can be installed by client, "○" which have to be installed by manufacturer. "—" which is not available.
 2. Specify rated current sensitivity when place the order.
 3. Ics= 50% Icu
 4. Adjustable thermal: 80%~100% In.
 5. Specify, when order delay type rated current sensitivity 30-100-500mA.

630		800					
BL630-UN		BL800-SN		BL800-HN		BL800-RN	
							
500, 630.		700, 800.		700, 800.		700, 800.	
1ø2W, 3ø3W.	3ø4W	1ø2W, 3ø3W.	3ø4W	1ø2W, 3ø3W.	3ø4W	1ø2W, 3ø3W.	3ø4W
3	4	3	4	3	4	3	4
230, 400.		230, 400.		230, 400.		230, 400.	
100- 300- 500 adjustable		100- 300- 500 adjustable		100- 300- 500 adjustable		100- 300- 500 adjustable	
0.04		0.04		0.04		0.04	
100- 300- 500 adjustable		100- 300- 500 adjustable		100- 300- 500 adjustable		100- 300- 500 adjustable	
0.45- 1.0- 2.0 adjustable		0.45- 1.0- 2.0 adjustable		0.45- 1.0- 2.0 adjustable		0.45- 1.0- 2.0 adjustable	
0.1, 0.5, 1.0		0.1, 0.5, 1.0		0.1, 0.5, 1.0		0.1, 0.5, 1.0	
Mechanical push-button		Mechanical push-button		Mechanical push-button		Mechanical push-button	
210	280	210	280	210	280	210	280
257		257		257		257	
103		103		103		103	
155		155		155		155	
243		243		243		243	
70		70		70		70	
10.0	13.0	10.5	13.5	10.5	13.5	10.5	13.5
85		50		70		85	
100		50		70		100	
125		85		100		125	
Busbar		Busbar		Busbar		Busbar	
●		●		●		●	
●		●		●		●	
●		●		●		●	
●		●		●		●	
●		●		●		●	
●		●		●		●	
○		○		○		○	
Fixed thermal Adj. magnetic		Fixed thermal Adj. magnetic		Fixed thermal Adj. magnetic		Fixed thermal Adj. magnetic	
Equipped		Equipped		Equipped		Equipped	

Index

MCCB
ELCB

ATS

ACB

MCB





SPD

MS



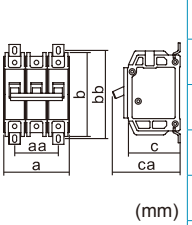

MMS

Molded Case Circuit Breaker

Bolt on type

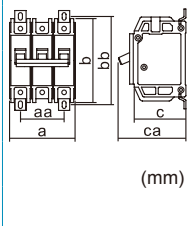

Frame (AF)		100			50	100			50	100			50	100		
Type		BP			BPH			BKH			BKS					
Appearance																
Rated Voltage (A.C) #1		110	220*	220	110	220*	220	110/220*	380	110/220*	220					
Rated Current In (A) At Ambient Temp. 40°C		10*, 15, 20, 30, 40, 50, 60, 75, 100.			15, 20, 30, 40, 50.			15, 20, 30, 40, 50, 60, 75, 100.			15, 20, 30, 40, 50, 60, 75, 100.					
Number of poles (P)		1	2	3	1	2	3	1	2	3	1	2	3			
Dimensions		a	25	50	75	25	50	75	25	50	75	25	50	75		
		b	95			95			95			95				
		c	58.5			58.5			58.5			58.5				
		ca	77.5			77.5			77.5			77.5				
		bb	100			100			100			100				
		aa	0	25	50	0	25	50	0	25	50	0	25	50		
		Weight (kg)	0.15	0.31	0.46	0.2	0.4	0.6	0.22	0.44	0.66	0.22	0.44	0.66		
Rated Breaking Capacity (kA) CNS 14816-2 Icu AC #2 #3	110V / 120V*	5	—	—	10	—	—	15	—	—	25/22**	—				
	220V / 240V*	—	5***	5	—	10	10	10	15	—	—	25/22**				
	380V / 400V*	—	—	—	—	—	—	—	10	—	—	—				
Trip Unit		Thermal Magnetic			Thermal Magnetic			Thermal Magnetic			Thermal Magnetic					

Plug in type

Frame (AF)		50			100			50			100			
Type		BL			BLH			BLS			BKL			
Appearance														
Rated Voltage (A.C) #1		110/220*	220	220	110/220*	220	220	110/220*	380					
Rated Current In (A) At Ambient Temp. 40°C		15, 20, 30 40, 50.	15, 20, 30, 40, 50 60, 75, 100.	15, 20, 30 40, 50.	15, 20, 30, 40, 50.	60, 75, 100.	15, 20, 30 40, 50.	15, 20, 30, 40, 50 60, 75, 100.						
Number of poles (P)		1	2	3	1	2	3	2	3	1	2	3		
Dimensions		a	25	50	75	25	50	75	50	75	25	50	75	
		b	74			74			74			79		
		c	60.5			60.5			60.5			61		
		ca	74			74			74			77.5		
		bb	—			—			—			—		
		aa	0	25	50	0	25	50	25	50	0	25	50	
		Weight (kg)	0.13	0.26	0.39	0.13	0.26	0.39	0.33	0.53	0.18	0.36	0.54	
Rated Breaking Capacity (kA) CNS 14816-2 Icu AC	110V / 120V*	5	—	—	10	—	—	15	—					
	220V / 240V*	—	5	—	—	10	10	10	15					
	380V / 400V*	—	—	—	—	—	—	—	10					
Trip Unit		Thermal Magnetic			Thermal Magnetic			Thermal Magnetic			Thermal Magnetic			



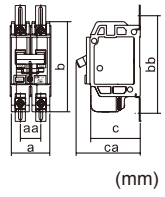

Note 1. "*/" 1 phase 3 wiring; L-L: 220V, L-N: 110V.
 2. "*/" Rated Breaking Capacity: asym/sym.
 3. "****" BP 1P 220V 5kA Rated Current:15, 20, 30, 40, 50A.

Earth Leakage Circuit Breaker | Earth Leakage, Overload, and Short Circuit Protection

Frame (AF)	50		50		50		50		50		
Type	BL-50L		BL-50UL		BLP-50L		BLP-50UL		BL-50H		
Appearance											
Rated Current In (A) At Ambient Temp. 40°C	15, 20, 30, 40, 50.										
Phase & Wire	1φ2W										
Number of poles (P)	2P1E	2P2E	2P1E	2P2E	2P1E	2P2E	2P1E	2P2E	2P1E	2P2E	
Rated Voltage (A.C.) #1.	110	220	220***	220	110	220	220***	220	220***	220/380	
Rated Current Sensitivity (mA) #2.	30, (100, 200, 300, 500)*				30				30, (100, 200, 300, 500)*		
Max. Operating Time (s)	≤0.1S										
Rated Breaking Capacity (kA) CNS 5422 Icu AC	110V	5	—	10	—	5	—	10	—	15	—
	220V	—	5	5	10	—	5	5	10	10	15
Dimensions  (mm)	a	25	50	25	50	25	50	25	50	50	75
	b	110				92				95	
	c	60				60.5				58.5	
	ca	78.4				78.4				77.5	
	bb	120				—				100	
	aa	0	25	0	25	0	25	0	25	25	50
Weight (kg)	0.22	0.39	0.22	0.39	0.2	0.34	0.2	0.34	0.4	0.58	
Trip Unit	Thermal Magnetic										
Earth Leakage Tripping Device	Mechanical										

**Earth Leakage,
Overload Protection**

Earth Leakage Protection

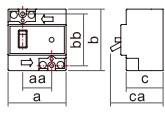
Frame (AF)	30		40		30		30	
Type	BL-KLF		BL-KF		BL-K30F		BL-BF	
Appearance								
Rated Current In(A) At Ambient Temp. 40°C	15, 20, 30		15, 20, 30, 40		15, 20, 30		15, 20, 30, 40	
Phase & Wire	1φ2W		1φ2W		1φ3W 3φ3W		1φ2W	
Poles (P)	2P1E	2P2E	2		3		2	
Rated Voltage (A.C.)	110~220		110~220		110~220	380~440	110~220	
Rated Current Sensitivity (mA) #2.	30		30, (100, 200, 300, 500)*		30		30, (100, 200, 300, 500)*	
Max. Operating Time (s)	≤0.1S		≤0.1S		≤0.1S		≤0.1S	
Rated Breaking Capacity (kA) CNS 5422 Icu AC	110V~220V	1.5	1.5, 2.5		1.5	—	1.5, 2.5	
	380V~480V	—	—		—	1.5	—	
Dimensions  (mm)	a	66		90		32		
	b	70		70		70		
	c	42		42		36		
	ca	60		60		48		
	bb	59		59		62		
	aa	33		57		—		
Weight (kg)	0.2		0.25		0.1		—	
Trip Unit	Thermal Magnetic				—			
Earth Leakage Tripping Device	Mechanical				—			

Note 1. "***" 3 phase 4 wiring, L-N: 220V
2. "*" Special order.

Optional Accessories Installation Table

■ AL: Alarm Switch / AX: Auxiliary Switch / SHT: Shunt Trip / UVT: Under Voltage Trip

Model	Poles	AL	AX	SHT or UVT	AL+AX	AL+ SHT or UVT	AX+ SHT or UVT	AL+AX+ SHT or UVT
BM30-SN BM50-CN BM60-SN/ HN BM100-SN / MN	3P							—
BL50-SN	3P 4P			 (#1.)	—	—	—	—
BM60-HBN BM100-HN BM125-SN/ HN	3P 4P			 (3P) (4P)		 (3P) (4P)	 (3P) (4P)	—
BL100-SN BL100-HN	3P 4P			 No UVT for 3P	—	 (#2.)	 (#2.)	—
BM100-H/ HC/ HS BM160-HB/ HC/ HS BM250-HB/ HC/ HS	3P 4P			 (#1.)		 (#1.)	 (#1.)	—
BM100-HBN BM160-SN/ HN BM250-SN/ HN	3P 4P							
BL160-SN BL250-SN	3P 4P				—	—	—	—
BM400-SN/ HN/ RN/ UN	3P 4P				 AX can be installed in AL position			
BL400-SN/ HN/ RN/ UN	3P 4P				 AX can be installed in AL position			—
BM630-SN/ HN/ RN/ UN BM800-CN/ SN/ HN/ RN	3P 4P				 AX can be installed in AL position			 AX can be installed in AL position
BL630-HN/ RN/ UN BL800-SN/ HN/ RN	3P 4P							
BM1000-HS BM1200-HS BM1600-HS	3P				—			—

2P, 125AF and below : Accessories are installed on the right side.

Note:

- Standard: AL and AX are installed on left side, SHT and UVT are installed on right side.
- SHT is equipped with coil anti-burn switch.
- BL series can not do right side installation.
- UVT of BM30-SN~BM100-HN can not install on its left side.
- #1 means have no UVT.
- #2 means only can apply to 4P breakers.

● : AL
○ : AX
■ : SHT or UVT

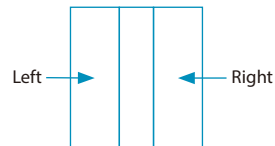

Optional Accessories | Application Table

External Handle

TYPE	Poles	Model
EH-100N	2P、3P、4P	BM30-SN, BM50-CN, BM60-SN/HN, BM100-SN/MN, BL50-SN
EH-125N	2P、3P、4P	BM60-HBN, BM100-HN, BM125-SN/HN, BL100-SN/HN
EH-250N	3P、4P	BM100-HBN, BM160-SN/HN, BM250-SN/HN, BL160-SN, BL250-SN
EH-400N	3P、4P	BM400-SN/HN/RN/UN, BL400-SN/HN/RN/UN
EH-800N	3P、4P	BM630-SN/HN/RN/UN, BM800-CN/SN/HN/RN, BL630-HN/RN/UN, BL800-SN/HN/RN
EH-250H	3P、4P	BM100-H/HC/HS, BM160-HB/HC/HS, BM250-HB/HC/HS

Manual Operation Device

TYPE	Poles	Model
MA-100N	3P、4P	BM30-SN, BM50-CN, BM60-SN/HN, BM100-SN/MN, BL50-SN
MA-125N	3P、4P	BM60-HBN, BM100-HN, BM125-SN/HN, BL100-SN/HN
MA-250N	3P、4P	BM100-HBN, BM160-SN/HN, BM250-SN/HN, BL160-SN, BL250-SN
MA-400N	3P、4P	BM400-SN/HN/RN/UN, BL400-SN/HN/RN/UN
MA-800N	3P、4P	BM630-SN/HN/RN/UN, BM800-CN/SN/HN/RN, BL630-HN/RN/UN, BL800-SN/HN/RN

Motor Operation Device

TYPE	Poles	Model
MT-100N	3P、4P	BM30-SN, BM50-CN, BM60-SN/HN, BM100-SN/MN, BL50-SN
MT-125N	3P、4P	BM60-HBN, BM100-HN, BM125-SN/HN, BL100-SN/HN
MT-250N	3P、4P	BM100-HBN, BM160-SN/HN, BM250-SN/HN, BL160-SN, BL250-SN
MT-400N	3P、4P	BM400-SN/HN/RN/UN, BL400-SN/HN/RN/UN
MT-800N	3P、4P	BM630-SN/HN/RN/UN, BM800-CN/SN/HN/RN, BL630-HN/RN/UN, BL800-SN/HN/RN
MT-250E	3P、4P	BM100-H/HC/HS, BM160-HB/HC/HS, BM250-HB/HC/HS

Note : Applicable voltage : ① DC 24V ② AC 110V/ DC 110V ③ AC 230V/ DC 220V

Rear Connection

TYPE	Poles	Model
PGI-100N50	3P	BM30-SN, BM50-CN, BM60-SN/HN, BL50-SN (50A and below)
PGI-100N	3P	BM60-SN/HN, BM100-SN/MN (60A and below)
PGI-125N50	3P	BM60-HBN, BM100-HN, BM125-SN/HN, BL100-SN/HN (50A and below)
	4P	BM100-HN, BM125-SN, BL100-SN/HN (50A and below)
PGI-125N	3P	BM60-HBN, BM100-HN, BM125-SN, BL100-SN/HN (60A and above)
	4P	BM100-HN, BM125-SN, BL100-SN/HN (60A and above)
PGI-250N	3P、4P	BM100-HBN, BM160-SN/HN, BM250-SN/HN, BL160-SN, BL250-SN
PGI-400N	3P、4P	BM400-SN/HN/RN/UN, BL400-SN/HN/RN/UN
PGI-800N	3P、4P	BM630-SN/HN/RN/UN, BM800-CN/SN/HN/RN, BL630-HN/RN/UN, BL800-SN/HN/RN
PGI-BM250	3P	BM100-H/HC/HS, BM160-HB/HC/HS, BM250-HB/HC/HS

Index

MCCB
ELCB

ATS

ACB

MCB

SPD

MS

MMS

Optional Accessories | Dimensions

External Handle

Type	Poles	fig.1			fig.2			fig.3		
		A	B	C	D	E	F	G	H	J
EH-100N	2P、3P、4P	104	105	39	90	78	10	* 25	111	M4 screw or $\phi 5$
EH-125N	2P、3P、4P	104	105	39	90	78	10	* 30	132	
EH-250N	3P, 4P	104	105	39	90	78	10	35	126	
EH-400N	3P, 4P	150	183	53	108	112	10	44	194	
EH-800N	3P, 4P	150	183	53	108	112	10	70	243	
EH-250H	3P, 4P	104	125	39	90	78	10	35	126.5	

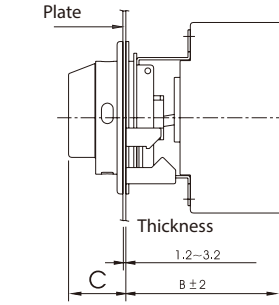
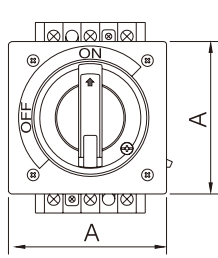
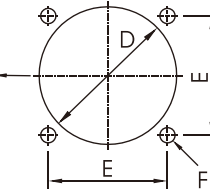
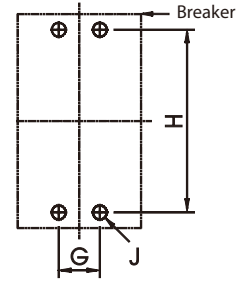

Fig. 1

Center of breaker and operation handle



Panel Dimension
Fig. 2



Breaker Dimension
Fig. 3

- Note:
1. Standard: White, optional: Black.
 2. Optional for dust and water protection.
 3. L: long type, EH100NL & EH125NL can not install to 2P.
 4. * indicates the value is not applied to 2P model.

Manual Operation Device

Type	Dimensions (mm)			
	A	B	H	Y
MA-100N	111	25	53.5	+8
MA-125N	132	30	54	+8
MA-250N	146	35	56	0
MA-400N	221	45	85	+10
MA-800N	242	70	85	+10

Motor Operation Device

Type	Dimensions (mm)						
	A	B	d	H	K	L	W
MT-100N	25	111	$\phi 4.5$	16.5	79	102	74
MT-125N	30	132	$\phi 4.5$	15	77	116	90
MT-250N	30	126	$\phi 4.5$	15	77	116	90
MT-400N	44	194	$\phi 4.5$	36	115	176	130
MT-800N	70	234	$\phi 4.5$	36	115	176	130
MT-250E	30	126	$\phi 4.5$	15	77	116	90

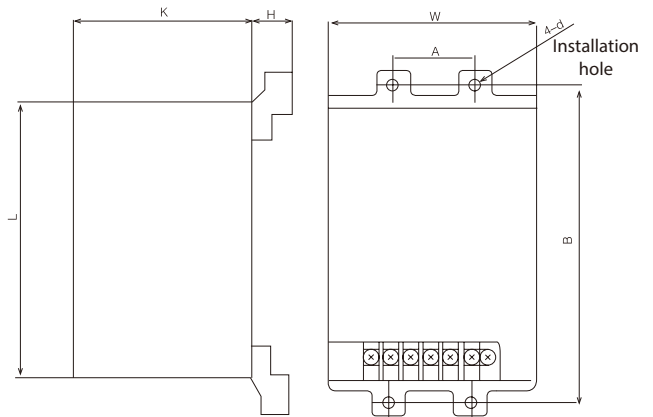
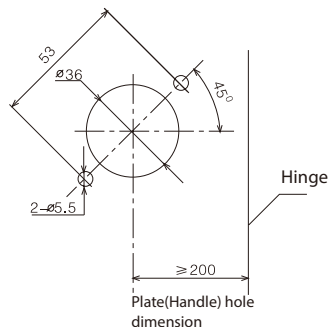
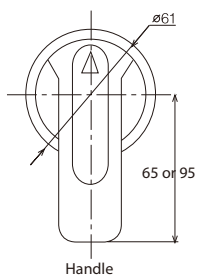
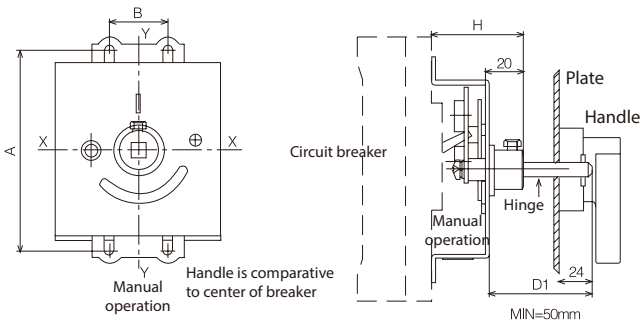

■ Rear Connection

Type	Poles	Dimensions (mm)																	Connect Direction		
		A	A1	B	B1	C	D	D1	E	F	G	H	H1	J	K	K1	K2	L	M	Horizontal	Vertical
PGI-100N	3	74	50	24	58	90	ø5	/	116	M10	9.5	28	12	M10	/	62	122	50	M4	⊙	⊙
	4	99	75															75			
PGI-125N	3	92	60	30	70	104	ø6	/	134	M10	13	26	16	M10	/	62	122	60	M5	⊙	⊙
	4	122	90															90			
PGI-250N	3	107	70	38	76	106	ø6	ø10	144	25	13	34	15	6	/	79	134	70	M5	⊙	⊙
	4	142	105															105			
PGI-400N	3	137	44	50	135	175	ø10	ø13	225	28	18	40	24	8	120	79	/	44	M8	⊙	⊙
	4	181	88															88			
PGI-800N	3	212	140	57	143	185	ø10	ø13	243	44	17	53	20	11	/	146	/	140	M8	⊙	⊙
	4	282	210															210			

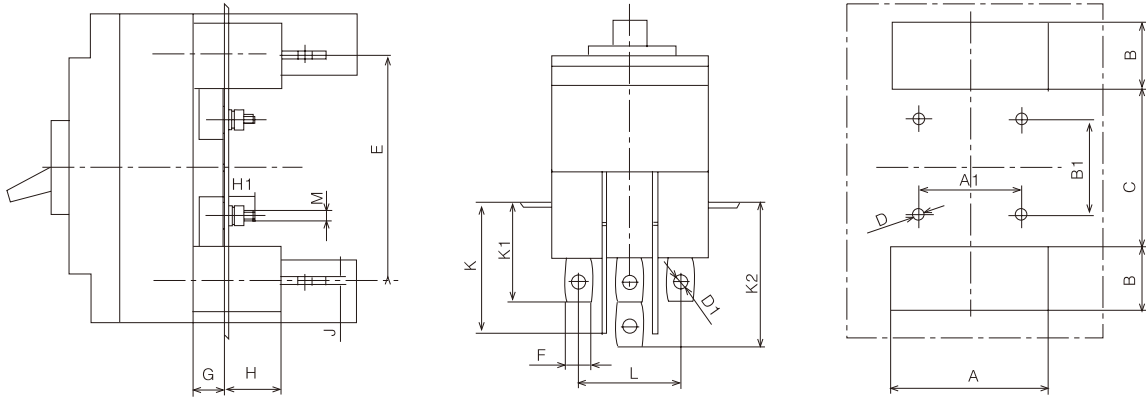

■ Rear Connection

Type	Poles	Dimensions (mm)																	Connect Direction		
		A	A1	B	B1	C	D	D1	E	F	G	H	H1	J	K	K1	K2	L	M	Horizontal	Vertical
PGI-BM250	3	107	70	38	76	106	ø6	ø10	144	25	13	34	15	6	/	79	134	70	M5	⊙	⊙

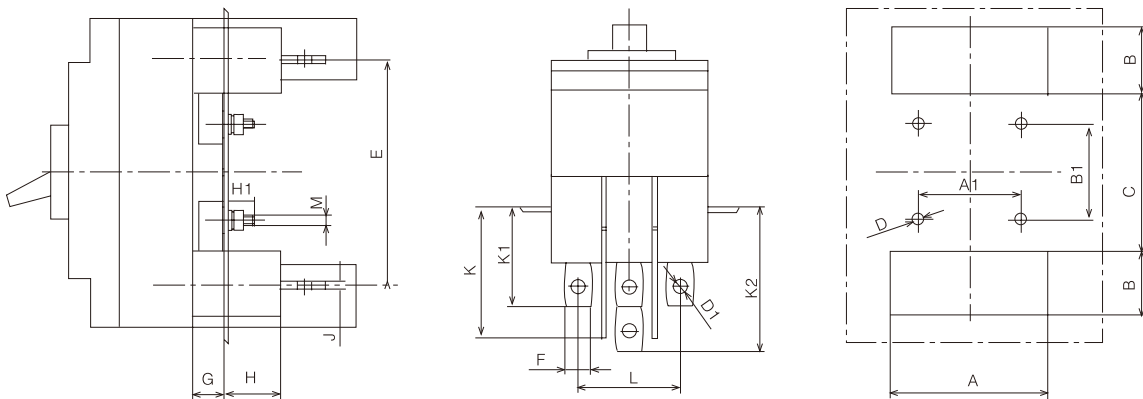

Index

MCCB
ELCB

ATS

ACB

MCB

SPD

MS

MMS



(Controller voltage: AC 220V)

ATS (Automatic Transfer Switches)

A. MCCB Type

Type	Pole	Rated current In (A)	Rated Breaking Capacity Sym r.m.s. (kA) IEC 60947-2 AC Icu	
			220V	380V
BS100SN	2P, 3P, 4P	10, 15, 20, 30, 40, 50, 60, 75, 100.	25	15
BS100HN	2P, 3P, 4P		50	30
BS250SN	2P, 3P, 4P	125, 150, 175, 200, 225, 250.	50	30
BS400SN	2P, 3P, 4P	250, 300, 350, 400.	50	35
BS400HN	2P, 3P, 4P		85	50
BS630SN	3P, 4P	500, 600, 630.	50	35
BS630HN	3P, 4P		85	50
BS800SN	3P, 4P	700, 800.	85	50
BS1000HS	3P	1000	130	100
BS1200HS	3P	1200	130	100
BS1600HS	3P	1400, 1600.	130	100

Note: 1. Standard: IEC 60947-2
 2. Special breaking capacity, please contact sales representative.
 3. BS225SN rated current 250A is optional order.



B. MS Type

Type	ATS Protection Switch	Rated current In (A)	Pole	Voltage
BS-MB	Miniature Circuit Breaker Protection Switch	20A	R, N	110V
			R, T	220V



Air Circuit Breaker

Model		BW-2000		BW-3200		BW-4000		BW-6300		
Frame size	AF	2000		3200		4000		6300		
Rated current (In)	A	630/800/1000/1250/1600/2000		2000/2500/3200		3200/4000		5000	6300	
Rated operation voltage(Ue)	V	AC400, 690V 50/60Hz		AC400, 690V 50/60Hz		AC400, 690V 50/60Hz		AC400, 690V 50/60Hz		
Rated insulation voltage (Ui)	V	AC1000 50/60Hz		AC1000 50/60Hz		AC1000 50/60Hz		AC1000 50/60Hz		
Rated impulse withstand voltage(Uimp)	kA	12		12		12		12		
Number of pole		3 / 4		3 / 4		3 / 4		3 / 4	3 / 4	
Rated current of N pole		100% In		100% In		100% In		100% In		
Type		HS	HN	HS	HN	HS	HN	HS		
Rated breaking capacity IEC60947-2	Icu / Ics (kA)	AC 400V	80 / 50	85 / 85	100 / 65	100 / 100	100 / 65	100 / 100	120/100	
		AC 690V	50 / 40	55 / 55	65 / 50	75 / 75	65 / 50	75 / 75	—	
	Icw (kA) @1 sec	AC 400V	50	65	65	85	65	85	100	
		AC 690V	—	55	—	75	—	75	—	
Endurance	Electrical	AC 400V	8000	8000	6500	6500	5000	5000	500	
		AC 690V	3000	3000	2500	2500	2500	2500	—	
	Mechanical	Without maintenance	10000	10000	10000	10000	10000	10000	2500	
		With maintenance	20000	20000	20000	20000	20000	20000	8000	
Electronic tripping device		A/P	A/P	A/P	A/P	A/P	A/P	A/P	A/P	
Connection		Horizontal		Horizontal		Horizontal		Horizontal		
Dimension	Drawout type H x W x L	3P	430 x 405 x 421		430 x 465 x 421		430 x 465 x 466		435 x 842 x 505	435 x 960 x 505
		4P	430 x 500 x 421		430 x 580 x 421		430 x 580 x 466		435 x 926 x 492	
	Fixed type H x W x L	3P	402 x 362 x 332		402 x 422 x 332		402 x 422 x 377		—	
		4P	402 x 455 x 332		402 x 537 x 332		402 x 537 x 377		—	

Note: The rated breaking capacity indicated by voltage which marked with * are for reference.

Index

MCCB
ELCB

ATS

ACB

MCB

SPD

MS

MMS

MCB (Miniature Circuit Breaker) | BHA Series

Applications:

Applicable to the residential, industrial and commercial power distribution systems, provide circuit-control and protection on equipments against any impacts of overload, short-circuit and earth leakage.
100AF also can be used for any of the application with low switching.

- DIN rail TH 35mm
- Ambient temperature: -5°C ~ +40°C

BHA

- Overload, Short Circuit



BHA	2	2	C	32		
Type	Rated short-circuit breaking capacity (kA) Rated voltage (V)	Poles (P)	Tripping characteristics	Rated current In (A)	Standard	Mechanical life
BHA	2: 4.5kA; 3: 6kA; 4: 10kA 230/400V	1, 2, 3, 4	C type: 5~ 10In D type: 10~ 15In	1, 2, 3, 4, 5, 6, 10, 16, 20, 25, 32, 40, 50, 63.	IEC 60898	20,000 operations
BHA	10kA 4: DC125V(1P) / DC250V(2P) 5: DC220V(1P) / DC440V(2P)	1, 2	DC Type	1, 2, 3, 4, 5, 6, 10, 16, 20, 25, 32, 40, 50, 63.	IEC 60947-2	20,000 operations

- BHA5 can't be used in IT system

BHL

- Overload, Short Circuit, Leakage



BHL	2	2	C	32	G
Type	Rated short-circuit breaking capacity (kA) Rated voltage (V)	Poles (P)	Tripping characteristics	Rated current In (A)	Optional function (2P)
BHL	2: 4.5kA; 3: 6kA 230V	1P+N	C type: 5~ 10In D type: 10~ 15In	6, 10, 16, 20, 25, 32, 40.	Over-voltage protection (230V, internal built)
BHL	2: 4.5kA 230V: 2P ; 400V: 3P/4P	2, 3, 4	C type: 5~ 10In D type: 10~ 15In	1, 2, 3, 4, 5, 6, 10, 16, 20, 25, 32, 40, 50, 63.	Over-voltage protection (230V, internal built)
BHL	3: 6kA 230/400V	2, 3, 4	C type: 5~ 10In D type: 10~ 15In	1, 2, 3, 4, 5, 6, 10, 16, 20, 25, 32, 40, 50, 63.	Over-voltage protection (230V, internal built)

- Standard: IEC 61009
- Internal OVT over voltage range AC 280V ± 5%

BHG

- Disconnect Switch



BHG		2	32		
Type	Rated voltage (V)	Poles (P)	Rated current In (A)	Standard	Mechanical life
BHG	230/400V	1, 2, 3, 4	32A, 40A, 63A, 80A, 100A.	IEC 60947-3	50,000 operations

BHN

- N+L Overload, Short Circuit



BHN	2	1	C	32
Type	Rated breaking capacity (kA) Rated voltage (V)	Poles (P)	Tripping characteristics	Rated current In (A)
BHN	2: 4.5kA; 3: 6kA 230V	1P+N	C type: 5~ 10In	6, 10, 16, 20, 25, 32.

- Standard: IEC 60898

Index

MCCB
ELCB

ATS

ACB

MCB

SPD

MS

MMS

BHK

• Accessories

BHK	2					1	
↓	↓					↓	
Type	Accessory Code					Installation	
	1	2	3	4	5	1	2
BHK	AL	AX	SHT	UVT	OVT	Standard	Option

Note: 1. Standard: Attached on left side of breaker
 2. Option: Attached on left side of accessory

Type	Auxiliary Contact	Width	Product Code
	AC/12	(mm)	



AL
Alarm Switch

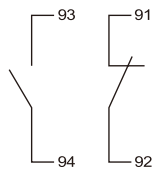

1NO, 1NC
230V 6A
440V 3A

9

BHK11



AX
Auxiliary Contact

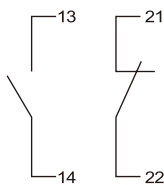

1NO, 1NC
230V 6A
440V 3A

9

BHK21
BHK22

Type	Control Voltage		Auxiliary Contact	Width	Product Code
	V AC	V DC	AC/12	(mm)	



SHT
Shunt Trip

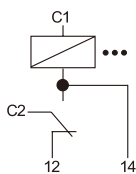

12	12
24-48	12-48
230-415	110-130

1NO, 1NC
230V 6A
440V 3A

18

BHK31
BHK32



UVT
Under Voltage Trip

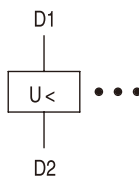

220-240

48

1NO, 1NC
230V 6A
440V 3A

18

BHK41
BHK42



OVT
Over Voltage Trip

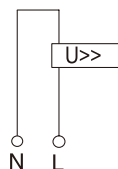

230V 15mA

280V ± 5%

≤ 0.2S

18

BHK51
BHK52

Type	Rated voltage	Current	Over voltage range	Trip time	Width (mm)	Product Code
------	---------------	---------	--------------------	-----------	------------	--------------

- Index
- MCCB
ELCB
- ATS
- ACB
- MCB
- SPD
- MS
- MMS

Surge Protective Device | BHP Series



BHP		20		3P		R		320			
Type	I _{max} /I _{imp} (kA)	Waveform (μs)	Pole (P)	R	U _c (V)	U _n (V)	U _p (kV)	Waveform (μs)	I _n (kA)	Connection wire diameter	
										L-N	PE
BHP20	20: 20kA	8/20	1P: 1P 1P1: 1P+1 2P: 1P+N 3P: 3P 3P1: 3P+1 4P: 3P+N	With alarm auxiliary contact	320	230/400	≤ 1.3	8/20	10	≧ 2.5mm ²	≧ 6mm ²
BHP40	40: 40kA	8/20			385	230/400	≤ 1.8	8/20	20	≧ 4mm ²	≧ 16mm ²
BHP80	80: 80kA	8/20			385	230/400	≤ 2.1	8/20	40	≧ 10mm ²	≧ 25mm ²
BHP100	100: 100kA	8/20			385	230/400	≤ 2.3	8/20	60	≧ 16mm ²	≧ 25mm ²
BHP250	250: 25kA	10/350			440	230/400	≤ 1.8	10/350	25	≧ 25mm ²	≧ 35mm ²

To enable the surge protective device to work, please read the following note:

1. The grounding system type of the protected device and maximum operating voltage of the power grid U_s. Max.
2. The impulse withstand voltage of the protected device.

Note: 1. BHP20, 40 are plug-in type; BHP80, 100, 250 are fixed type.
2. The standard operation voltage U_c(V) is below table. Max operation voltage U_c(V): 660V.

SPD Counter

Model	TAD-04-99
Rated Voltage	85~250V
Max. Count	99
Display	LED
Dimension (mm)	91X69X18

Normal working conditions

- Frequency: the AC power frequency shall be 50/60Hz.
- Voltage: the voltage continuously supplied between the wiring terminals of the surge protective device shall not exceed its maximum continuous operating voltage U_c.
- Altitude: less than 2,000m.
- Use and storage temperature: -Normal range: -5°C ~ +40°C;
-Ultimate range: -40°C ~ +80°C;
- Humidity: Relative humidity 30%~90% under ambient temperature.

Magnetic Contactor / Motor Starter ◆ AC control



Model		06	09	11	12			
Type	Magnetic Contactor	Nonreversing	S-P06	S-P09	S-P11	S-P12		
		Reversing	S-2×P06	S-2×P09	S-2×P11	S-2×P12		
	Motor Starter	without enclosure	Nonreversing	MSO-P06	MSO-P09	MSO-P11	MSO-P12	
			Reversing	—	—	MSO-2×P11	MSO-2×P12	
		with enclosure	Nonreversing	—	—	MS-P11	MS-P12	
			Reversing	—	—	MS-2×P11	MS-2×P12	
	with enclosure (push button)	Nonreversing	—	—	MS-P11PB	MS-P12PB		
	TOR	Standard	—	—	TH-P12 E	TH-P12 E		
		Differential	TH-P09PP	TH-P09PP	TH-P12PP	TH-P12PP		
	Rated Capacity	IEC 60947-4-1 EN 60947-4-1 DIN VDE 0660 AC 3 (kW/HP/A)	3 ∅	240V	1.5/ 2/ 7.5	2.2/ 3/ 10.1	3.5/ 4.5/ 13	3.5/ 4.5/ 13
380/415V				3/ 4/ 6.6	4/ 5.5/ 9	5.5/ 7.5/ 12	5.5/ 7.5/ 12	
440V				3/ 4/ 6.5	4/ 5.5/ 8.5	5.5/ 7.5/ 12	5.5/ 7.5/ 12	
550V				3/ 4/ 5	4/ 5.5/ 6.5	5.5/ 7.5/ 9	5.5/ 7.5/ 9	
660V				3/ 4/ 4	4/ 5.5/ 5	5.5/ 7.5/ 7	5.5/ 7.5/ 7	
Operation current (lth) AC1 (A)			20	20	20	20		
Rated insulation voltage (V)		AC660	AC660	AC660	AC660			
UL 508 CSA-C22.2 AC3 (HP/A)		1 ∅	100~120V	0.25/ 5.8	0.5/ 9.8	0.5/ 9.8	0.5/ 9.8	
			200~240V	1/ 8	1.5/ 10	2/ 10	2/ 12	
		3 ∅	200~240V	2/ 6.8	3/ 9.6	3/ 9.6	3/ 9.6	
			380~480V	3/ 4.8	5/ 7.6	7.5/ 11	7.5/ 11	
			550~600V	3/ 3.9	5/ 6.1	10/ 11	10/ 11	
		Operation current (lth) AC1 (A)	20	20	24	24		
Rated insulation voltage (V)		AC660	AC660	AC600	AC600			
NEMA		00	00	0	0			
Auxiliary Contact		IEC 60947-5-1 EN 60947-5-1 GB14048.4 AC 15	Contact	Standard	1NO	1NO	1NO	1NO 1NC
				Special	1NC	1NC	1NC	2NC or 2NO
				220V	3.3	3.3	1.6	1.6
	380V			1.9	1.9	0.95	0.95	
	Operation current (lth) AC1 (A)	10	10	16	16			
	Contact class (UL)	A600	A600	A600, P600, Q300	A600, P600, Q300			
Electrical Life AC3		1.6 Mil.	1.6 Mil.	1.6 Mil.	1.6 Mil.			
Mechanical Life		10 Mil.	10 Mil.	10 Mil.	10 Mil.			
Magnetic Contactor	Weight (kg)		0.15	0.15	0.33	0.35		
	Appearance Dimensions (H×W×D) (mm)		46×58×51	46×58×51	43×81×83.5	53×81×83.5		
	Installation Dimension (mm)							
Mechanical Interlock		—	—	MPU-11	MPU-21			

Motor Starter

Index

MCCB
ELCB

ATS

ACB

MCB

SPD

MS

MMS

BO

27

Magnetic Contactor / Motor Starter ◆ AC control



Model		15	16	21 (A)	25		
Type	Magnetic Contactor	Nonreversing	S-P15	S-P16	S-P21 (A)	S-P25	
		Reversing	S-2×P15	S-2×P16	S-2×P21 (A)	S-2×P25	
	Motor Starter	without enclosure	Nonreversing	MSO-P15	MSO-P16	MSO-P21 (A)	MSO-P25
			Reversing	MSO-2×P15	MSO-2×P16	MSO-2×P21 (A)	MSO-2×P25
		with enclosure	Nonreversing	MS-P15	MS-P16	MS-P21 (A)	MS-P25
			Reversing	MS-2×P15	MS-2×P16	MS-2×P21 (A)	MS-2×P25
		with enclosure (push button)	Nonreversing	MS-P15PB	MS-P16PB	MS-P21PB (A)	MS-P25PB
	TOR	Standard	TH-P12 E	TH-P20 E	TH-P20 E	TH-P20 E(TA)	
		Differential	TH-P12PP	TH-P20PP	TH-P20PP	TH-P20(TA)PP	
	Rated Capacity	IEC 60947-4-1 EN 60947-4-1 DIN VDE 0660	3 Ø	240V	4.5/ 6/ 18	4.5/ 6/ 18	5.5/ 7.5/ 24
380/415V				7.5/ 10/ 18	7.5/ 10/ 18	11/ 15/ 21	12/ 16/ 25
440V				7.5/ 10/ 16	7.5/ 10/ 16	11/ 15/ 21	12/ 16/ 23
550V				7.5/ 10/ 13	7.5/ 10/ 13	11/ 15/ 17	12/ 16/ 20
660V				7.5/ 10/ 9	7.5/ 10/ 9	11/ 15/ 14	12/ 16/ 16
AC 3 (kW/HP/A)		Continuous current (Ith) AC1 (A)	25	30	32	32	
		Rated insulation voltage (Ui) (V)	AC660	AC660	AC660	AC660	
UL 508 CSA-C22.2 AC3 (HP/A)		1 Ø	100~120V	—	1/ 16	2/ 24	2/ 24
			200~240V	—	3/ 17	3/ 17	3/ 17
		3 Ø	200~240V	—	5/ 15.2	7.5/ 22	10/ 28
			380~480V	—	10/ 14	15/ 21	15/ 21
			550~600V	—	10/ 11	15/ 17	15/ 17
		Operation current (Ith) AC1 (A)	—	30	35	40	
		Rated insulation voltage (Ui) (V)	—	AC600	AC600	AC600	
NEMA		0	0	1	1		
Auxiliary Contact	IEC 60947-5-1 EN 60947-5-1 GB14048.4 AC 15	Contact	Standard	1NO	1NO 1NC	1NO 1NC (2NO 2NC)	1NO 1NC
			Special	1NC	—	—	—
		220V	1.6	1.6	1.6	1.6	
		380V	0.95	0.95	0.95	0.95	
	Continuous current (Ith) AC1 (A)	16	16	16	16		
	Contact class (UL)	—	A600, Q300	A600, Q300	A600, Q300		
Electrical Life	AC3	1.3 Mil.	1.3 Mil.	1.3 Mil.	1.3 Mil.		
Mechanical Life		10 Mil.	10 Mil.	10 Mil.	10 Mil.		
Magnetic Contactor	Weight (kg)	0.33	0.37	0.38	0.38		
	Appearance Dimensions (H×W×D) (mm)	43×81×83.5	53.5×81×83.5	53.5×81×83.5	53.5×81×83.5		
	Installation Dimension (mm)						
Mechanical Interlock		MPU-11	MPU-21	MPU-21	MPU-21		



30T	35T	40T	50T	60T
S-P30T	S-P35T	S-P40T	S-P50T	S-P60T
S-2×P30T	S-2×P35T	S-2×P40T	S-2×P50T	S-2×P60T
MSO-P30T	MSO-P35T	MSO-P40T	MSO-P50T	MSO-P60T
MSO-2×P30T	MSO-2×P35T	MSO-2×P40T	MSO-2×P50T	MSO-2×P60T
MS-P30T	MS-P35T	MS-P40T	MS-P50T	MS-P60T
MS-2×P30T	MS-2×P35T	MS-2×P40T	MS-2×P50T	MS-2×P60T
MS-P30TPB	MS-P35TPB	MS-P40TPB	MS-P50TPB	MS-P60TPB
TH-P20 E(TA)	TH-P20 E(TA)	TH-P20 E(TA)	TH-P60 E	TH-P60 E(TA)
TH-P20(TA)PP	TH-P20(TA)PP	TH-P20(TA)PP	TH-P60PP	TH-P60(TA)PP
7.5/ 10/ 30	9/ 12.5/ 35	11/ 15/ 44	15/ 20/ 58	19/ 25/ 65
15/ 20/ 30	18.5/ 25/ 35	22/ 30/ 40	30/ 40/ 52	37/ 50/ 65
15/ 20/ 27	18.5/ 25/ 27	22/ 30/ 40	30/ 40/ 52	37/ 50/ 65
15/ 20/ 22	18.5/ 25/ 22	22/ 30/ 32	30/ 40/ 41	37/ 50/ 52
15/ 20/ 18	18.5/ 25/ 18	22/ 30/ 26	30/ 40/ 34	37/ 50/ 43
50	50	50	80	90
AC660	AC660	AC660	AC660	AC660
2/ 24	2/ 24	3/ 34	5/ 56	5/ 56
5/ 28	5/ 28	7.5/ 40	10/ 50	10/ 50
10/ 28	10/ 28	15/ 42	20/ 54	20/ 54
20/ 27	20/ 27	20/ 27	30/ 40	40/ 52
30/ 32	30/ 32	30/ 32	40/ 41	50/ 52
50	50	50	80	90
AC600	AC600	AC600	AC600	AC600
2	2	2	2	2
2NO 2NC	2NO 2NC	2NO 2NC	2NO 2NC	2NO 2NC
—	—	—	—	—
1.6	1.6	1.6	1.6	1.6
0.95	0.95	0.95	0.95	0.95
16	16	16	16	16
A600, Q300	A600, Q300	A600, Q300	A600, Q300	A600, Q300
1.3 Mil.	1.3 Mil.	1.3 Mil.	1.3 Mil.	1.3 Mil.
10 Mil.	10 Mil.	10 Mil.	6 Mil.	6 Mil.
0.55	0.55	0.55	1.05	1.05
73×95×93	73×95×93	73×95×93	87.9×115×107	87.9×115×107

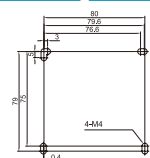
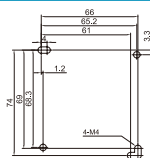

MPU-11	MPU-11	MPU-11	MPU-11	MPU-11
--------	--------	--------	--------	--------

Index

MCCB
ELCB

ATS

ACB

MCB

SPD

MS

MMS

Magnetic Contactor / Motor Starter ◆ AC control

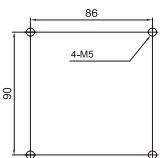
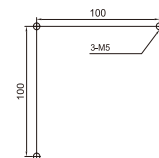
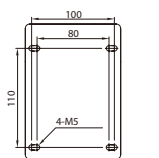

Model		80T	100T	125T	150T		
Type	Magnetic Contactor	Nonreversing	S-P80T	S-P100T	S-P125T	S-P150T	
		Reversing	S-2×P80T	S-2×P100T	S-2×P125T	S-2×P150T	
	Motor Starter	without enclosure	Nonreversing	MSO-P80T	MSO-P100T	MSO-P125T	MSO-P150T
			Reversing	MSO-2×P80T	MSO-2×P100T	MSO-2×P125T	MSO-2×P150T
		with enclosure	Nonreversing	MS-P80T	MS-P100T	MS-P125T	MS-P150T
			Reversing	MS-2×P80T	MS-2×P100T	MS-2×P125T	MS-2×P150T
		with enclosure (push button)	Nonreversing	—	—	—	—
	TOR	Standard	TH-P60 E(TA)	TH-P120 E(TA)	TH-P120 E(TA)	TH-P120 E(TA)	
		Differential	TH-P60(TA)PP	TH-P120(TA)PP	TH-P120(TA)PP	TH-P120(TA)PP	
	Rated Capacity	IEC 60947-4-1 EN 60947-4-1 DIN VDE 0660	3 Ø	240V	22/ 30/ 80	30/ 40/ 105	37/ 50/ 135
380/415V				45/ 60/ 80	60/ 80/ 105	75/ 100/ 130	90/ 125/ 160
440V				45/ 60/ 75	60/ 80/ 105	75/ 100/ 130	90/ 125/ 160
550V				45/ 60/ 60	60/ 80/ 85	75/ 100/ 105	90/ 125/ 130
660V				45/ 60/ 50	60/ 80/ 70	75/ 100/ 90	90/ 125/ 110
AC 3 (kW/HP/A)		Continuous current (Ith)	AC1 (A)	100	135	170	200
		Rated insulation voltage (Ui)	(V)	AC660	AC660	AC660	AC660
UL 508 CSA-C22.2 AC3 (HP/A)		1 Ø	100~120V	7.5/ 80	—	—	—
			200~240V	15/ 68	—	—	—
		3 Ø	200~240V	25/ 68	30/ 80	50/ 130	60/ 154
			380~480V	50/ 65	60/ 77	100/ 124	125/ 156
			550~600V	60/ 62	60/ 62	100/ 99	125/ 125
		Continuous current (Ith)	AC1 (A)	90	100	170	200
		Rated insulation voltage (Ui)	(V)	AC600	AC600	AC600	AC600
NEMA		3	3	3	3		
Auxiliary Contact	IEC 60947-5-1 EN 60947-5-1 GB14048.4 AC 15	Contact	Standard	2NO 2NC	2NO 2NC	2NO 2NC	2NO 2NC
			Special	—	—	—	—
			220V	1.6	1.6	3.3	3.3
			380V	0.95	0.95	1.6	1.6
	Operation current (Ith)	AC1 (A)	16	16	16	16	
	Contact class	(UL)	A600, Q300	A600, Q300	A600, Q300	A600, Q300	
Electrical Life	AC3	1.2 Mil.	1.2 Mil.	1.2 Mil.	1.2 Mil.		
Mechanical Life		6 Mil.	6 Mil.	6 Mil.	6 Mil.		
Magnetic Contactor	Weight	(kg)	1.5	2.35	2.7	2.7	
	Appearance Dimensions (H×W×D)	(mm)	100×142×116	120×116×128	106×152.5×140	106×152.5×140	
	Installation Dimension	(mm)					
Mechanical Interlock		MPU-50	Assembled and adjusted by the factory.	MPU-125	MPU-125		

Index

MCCB
ELCB

ATS

ACB

MCB

SPD

MS

MMS

BO

30



200T	220T	300T	400T	600C
S-P200T	S-P220T	S-P300T	S-P400T	M-600C
S-2×P200T	S-2×P220T	S-2×P300T	S-2×P400T	RC-600C
MSO-P200T	MSO-P220T	MSO-P300T	MSO-P400T	—
MSO-2×P200T	MSO-2×P220T	MSO-2×P300T	MSO-2×P400T	—
MS-P200T	MS-P220T	—	—	—
MS-2×P200T	MS-2×P220T	—	—	—
—	—	—	—	—
TH-P220T E	TH-P220T E	TH-P400T E	TH-P400T E	TH-P600CT(E)
TH-P220TPP	TH-P220TPP	TH-P400TPP	TH-P400TPP	TH-P600CTPP
55/ 75/ 200	65/ 85/ 225	90/ 125/ 300	110/ 150/ 400	160/ 220/ 620
110/ 150/ 200	120/ 160/ 220	160/ 220/ 300	220/ 300/ 400	315/ 420/ 600
110/ 150/ 190	120/ 160/ 220	185/ 250/ 300	250/ 340/ 400	315/ 420/ 600
110/ 150/ 150	132/ 180/ 180	185/ 250/ 263	250/ 340/ 360	315/ 420/ 500
110/ 150/ 125	132/ 180/ 150	200/ 300/ 220	280/ 380/ 305	—
240	260	350	450	660
AC660	AC660	AC1000	AC1000	AC660
—	—	—	—	—
—	—	—	—	—
75/ 192	75/ 192	100/ 248	125/ 312	—
150/ 180	150/ 180	200/ 240	250/ 302	—
150/ 144	150/ 144	200/ 192	300/ 289	—
240	260	350	450	—
AC600	AC600	AC1000	AC1000	—
4	4	5	5	6
2NO 2NC	2NO 2NC	2NO 2NC	2NO 2NC	2NO 2NC
—	—	—	—	—
3.3	3.3	3.3	3.3	1.6
1.6	1.6	1.6	1.6	0.95
16	16	10	10	16
A600, Q300	A600, Q300	A600, Q300	A600, Q300	A600, Q300
1.2 Mil.	1.2 Mil.	1.2 Mil.	1.2 Mil.	0.6 Mil.
6 Mil.	6 Mil.	6 Mil.	6 Mil.	6 Mil.
4.35	4.35	9.75	9.75	28
138×185×159.5	138×185×159.5	164×246×196.5	164×246×196.5	360×320×234

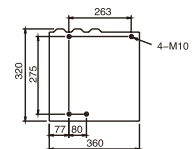
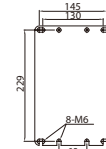
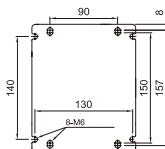

MPU-125	MPU-125	MPU-125	MPU-125	—
---------	---------	---------	---------	---

Index

MCCB
ELCB

ATS

ACB

MCB

SPD

MS

MMS

Magnetic Contactor / Motor Starter ◆ DC control



Type	Magnetic Contactor	Nonreversing		SD-P11	SD-P16	SD-P21
		Reversing		SD-2×P11	SD-2×P16	SD-2×P21
	Motor Starter	without enclosure	Nonreversing	MDO-P11	MDO-P16	MDO-P21
			Reversing	MDO-2×P11	MDO-2×P16	MDO-2×P21
		with enclosure	Nonreversing	—	—	—
			Reversing	—	—	—
		with enclosure (push button)	Nonreversing	—	—	—
	TOR	Standard		TH-P12	TH-P20	TH-P20
		Differential		TH-P12PP	TH-P20PP	TH-P20PP
	Rated Capacity	IEC 60947-4-1 EN 60947-4-1 DIN VDE 0660 AC 3 (kW/HP/A)	3 ∅	240V	3.5/ 4.5/ 13	4.5/ 6/ 18
380/440V				5.5/ 7.5/ 12	7.5/ 10/ 18	11/ 15/ 21
550V				5.5/ 7.5/ 9	7.5/ 10/ 13	11/ 15/ 17
660V				5.5/ 7.5/ 7	7.5/ 10/ 9	11/ 15/ 14
Continuous current (lth)		AC1 (A)	20	30	32	
UL 508 CSA-C22.2 AC3 (HP/A)		1 ∅	110~120V	0.5/ 9.8	1/ 16	2/ 24
			220~240V	2/ 12	3/ 17	3/ 17
		3 ∅	220~240V	3/ 9.6	5/ 15.2	7.5/ 22
			440~480V	7.5/ 11	10/ 14	15/ 21
		550~600V		10/ 11	10/ 11	15/ 17
Continuous current (lth)		AC1 (A)	24	30	35	
NEMA			0	0	1	
Auxiliary contact			1NO or 1NC	1NO 1NC	1NO 1NC	
Control coil voltage DC (V)			12/ 24/ 48/ 72/ 110/ 125/ 220			
Electrical Life AC3 (10 thousand)			120	120	120	
Mechanical Life (10 thousand)			600	600	600	
Magnetic Contactor	Weight (kg)		0.33	0.37	0.38	
	Appearance Dimensions (H×W×D) (mm)		43×81×83.5	53.5×81×83.5	53.5×81×83.5	
	Installation Dimension (mm)					
Mechanical Interlock			MPU-11	MPU-11	MPU-11	

Capacitor Contactors



Type		SC-P12	SC-P16	SC-P20	SC-P25	SC-P33	SC-P45	SC-P60	
Rated Insulation voltage (Ui) (V)		690	690	690	690	690	690	690	
Rated Capacity	IEC 60947-4-1 EN 60947-4-1 DIN VDE 0660 AC 3 (kW/HP/A) AC-6b 3 φ (kVar/A)	200~240V	6.7/ 18	8.5/ 22	10/ 26	15/ 39	20/ 48	25/ 66	35/ 92
		400~440V	12.5/ 16	16.7/ 22	20/ 26	25/ 33	33.3/ 44	45/ 59	60/ 86
		660~690V	18/ 15	24/ 20	30/ 25	36/ 30	48/ 40	58/ 49	75/ 63
	Continuous current (Ith) AC1 (A)	20	30	40	50	80	90	100	
Auxiliary Contact		2NO or 1NO 1NC	2NO 1NC	2NO 1NC	3NO 2NC	3NO 2NC	3NO 2NC	3NO 2NC	
Auxiliary Contact	IEC 60947-5-1 EN 60947-5-1 AC12 (A)	100~120V	6	6	6	6	6	6	
		200~220V	5	5	5	5	5	5	
		380~440V	3	3	3	3	3	3	
		550~600V	3	3	3	3	3	3	
	Continuous current (Ith) (A)	16	16	16	16	16	16	16	
Mechanical Life / Electrical Life (AC-6b) ≤440V (10 thousand)		100 / 30	100 / 30	100 / 30	100 / 30	100 / 30	100 / 30	100 / 30	
Operation frequency (time/ hour)		240	240	240	240	240	240	100	
Capacitor unit		AP-40 A	AP-40 A	AP-40 A	AP-40 B	AP-40 B	AP-40 B	AP-40 B	
Magnetic Contactor	Weight (kg)	0.42	0.47	0.47	0.63	1.14	1.14	1.59	
	Appearance Dimensions (H×W×D) (mm)	44×108×134	54×112×134	54×112×134	74×185×144	89×185×158	89×185×158	101×195×168	
	Installation Dimension (mm)								

Capacitor Unit



Capacitor Unit	Magnetic Contactor	Maximum operating power(kvar)		
		220~240V	400~440V	660~690V
AP-40-A	S-P11	6.7	12.5	18
	S-P16	8.5	16.7	24
	S-P21	10	20	30
AP-40-B	S-P40T	15	25	36
	S-P50T	20	33.3	48
	S-P60T	25	45	58
	S-P80T	35	60	75

Index

MCCB
ELCB

ATS

ACB

MCB

SPD

MS

MMS

Thermal Overload Relay



Type		09		12		20			
Standard	Contactored Assembled Type	—		TH-P12E		TH-P20E		TH-P20ETA	
	#3 Separate Installed Type	—		TH-P12ER		—		—	
Differential type	Contactored Assembled Type	TH-P09PP		TH-P12PP		TH-P20PP		TH-P20TAPP	
	#3 Separate Installed Type	—		TH-P12PPR		—		—	
Reset Mode		Manual / Automatic		Manual / Automatic		Manual / Automatic			
Magnetic Contactor		S-P06, S-P09.		S-P11, S-P12, S-P15.		S-P16, S-P21, S-P25, S-P30T, S-P35T, S-P40T.		S-P25, S-P30T, S-P35T, S-P40T.	
Index	TOR Adjustment Range (A)	Rating (A)	Range (A)	Rating (A)	Range (A)	Rating (A)	Range (A)	Rating (A)	Range (A)
		0.13	0.1~0.16	0.25	0.19~0.31	0.25	0.19~0.31	28	22~34
		0.20	0.16~0.24	0.4	0.3~0.5	0.4	0.3~0.5	33	28~38
		0.32	0.24~0.4	0.6	0.45~0.75	0.6	0.45~0.75	40	32~48
		0.5	0.4~0.6	0.9	0.7~1.1	0.9	0.7~1.1		
		0.8	0.6~1	1.2	0.9~1.5	1.2	0.9~1.5		
		1.3	1~1.6	1.7	1.3~2.1	1.7	1.3~2.1		
		2.0	1.6~2.4	2.1	1.6~2.6	2.1	1.6~2.6		
		3.2	2.4~4	3.3	2.5~4.1	3.3	2.5~4.1		
		5	4~6	4.4	3.4~5.4	4.4	3.4~5.4		
		7.5	6~9	6.5	5~8	6.5	5~8		
						9	7~11	9	7~11
				11	9~13	11	9~13		
				15	12~18	15	12~18		
						21	17~24		
Auxiliary Contact		—		—		1NO 1NC			
Weight		0.075		0.11/0.12		0.18/0.19		0.20/0.21	
Appearance Dimensions (H×W×D)		45.5×64.8×50		TH-P12(PP): 45.5×55.5×78 TH-P12(PP)R: 47×71×86.2		TH-P20(PP): 64.5×46.1×80		TH-P20TA(PP): 64.5×56.2×80	

Installation Dimensions (mm)

TH-P12(PP):
TH-P12(PP)R:

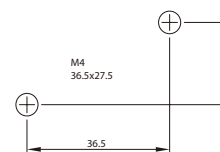
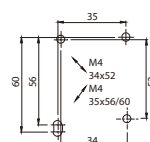

- Note. 1. The purpose of using TOR is protecting load tripping. For protecting circuit, please choose circuit breaker.
 2. When adjusting the rated current; please refer to the TOR range table above. Do not exceed its range.
 3. (E): 3 Elements

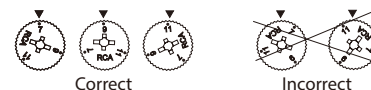

60		120		220T	400T	600CT							
TH-P60E	TH-P60ETA	TH-P120E	TH-P120ETA	TH-P220TE	TH-P400TE	TH-P600CTE							
–	–	–	–	–	–	–							
TH-P60PP	TH-P60TAPP	TH-P120PP	TH-P120TAPP	TH-P220TPP	TH-P400TPP	TH-P600CTPP							
–	–	–	–	–	–	–							
Manual / Automatic		Manual / Automatic		Manual / Automatic	Manual / Automatic	Manual / Automatic							
S-P50T, S-P60T, S-P80T.		S-P60T, S-P80T.		S-P100T, S-P125T, S-P150T.		S-P200T, S-P220T.							
S-P300T, S-P400T.		M-600C											
Rated (A)	Adjustable Range (A)	Rated (A)	Adjustable Range (A)	Rated (A)	Adjustable Range (A)	Rated (A)	Adjustable Range (A)	Rated (A)	Adjustable Range (A)	Rated (A)	Adjustable Range (A)	Rated (A)	Adjustable Range (A)
11	9~13	67	54~80	40	32~48	105	80~130	80	60~100	105	80~130	260	200~320
15	12~18	80	60~100	54	43~65	130	100~160	105	80~130	130	100~160	350	260~440
21	17~24			67	54~80	160	120~200	130	100~160	160	120~200	500	400~600
28	22~34			80	60~100			160	120~200	200	150~250		
33	28~38							200	150~250	260	200~320		
40	32~48									350	260~440		
54	43~65												
1NO 1NC		1NO 1NC		1NO 1NC		1NO 1NC		1NO 1NC		1NO 1NC		1NO 1NC	
0.28/ 0.30		0.34/ 0.36		0.55		0.76		2.25		2.65		3.93/ 3.95	
TH-P60(PP): 98×50.5×78		TH-P60TA(PP): 64.5×65.5×80		TH-P120(PP): 133×54×105		TH-P120TA(PP): 133×85.5×105		140×151.5×158.7		164×165×163.7		TOR: 64.5×46.1×80 TOR W/CT: 106×46.8×104.5	

Index

MCCB
ELCB

ATS

ACB

MCB

SPD

MS

MMS

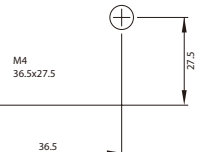
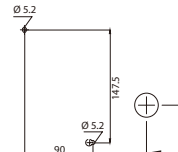
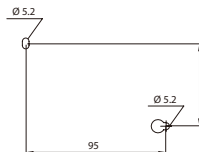
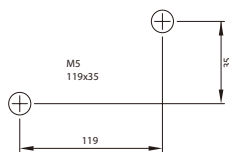
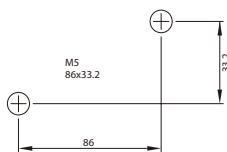



Magnetic Control Relays



Type		SR-P40	SR-P50	SR-P80
Auxiliary Contact		4NO 3NO 1NC 2NO 2NC	5NO 4NO 1NC 3NO 2NC 2NO 3NC	8NO 7NO 1NC 6NO 2NC 5NO 3NC 4NO 4NC
Rated Capacity IEC 60947-4-1 AC15 (A)	220V	1.6	1.6	1.6
	380V	0.95	0.95	0.95
Rated insulation voltage	(Ui) (V)	660	660	660
Operation current	(Ith) (A)	16	16	16
Contact Class	(UL)	A600, Q300	A600, Q300	A600, Q300
Electrical Life	(10 thousand)	50 and up	50 and up	50 and up
Mechanical Life	(10 thousand)	500	500	500
On/ Off Frequency	(time per / hour)	500	500	500

Definite Purpose Magnetic Contactor | SF Series

Type		20	25	30	35	40
		 C1	 C2	 C3		
Type	1 Pole	SF20C1	SF25C1	SF30C1	SF35C1	SF40C1
	2 Pole	SF20C2	SF25C2	SF30C2	SF35C2	SF40C2
	1Pole w/shunt	SF20C3	SF25C3	SF30C3	SF35C3	SF40C3
Start Current(A) (Per Pole)	AC 240V / AC 277V	120	150	180	180	180
	AC 480V	100	125	150	150	150
	AC 600V	80	100	120	120	120
Start Current(A) (Single Phase) (2 Pole)	AC 240V / AC 277V	120	150	180	210	240
	AC 480V	100	125	150	175	200
	AC 600V	80	100	120	140	160
Rated Current w/resistance load (A)		30	35	40	50	50
Full Rated Current (A)		20	25	30	35	40
Mechanical / Electrical life (10 thousand)		50/25	50/25	50/25	50/25	50/25
Operation frequency (time / hour)		360	360	360	360	360
Coil Control Voltage 50/60 Hz		24 / 110-120 / 200 / 220 / 208-240 / 277				

Star-delta Starter



Model		21	35	50	60	80	100	125	150	220
Type	Without enclosure (no CT)	SDO-P21	SDO-P35	SDO-P50	SDO-P60	SDO-P80	SDO-P100	SDO-P125	SDO-P150	SDO-P220
	Without enclosure (with CT)	SDO-P21T	SDO-P35T	SDO-P50T	SDO-P60T	SDO-P80T	SDO-P100T	SDO-P125T	SDO-P150T	SDO-P220T
	With enclosure (no Ammeter)	SDE-P21	SDE-P35	SDE-P50	SDE-P60	SDE-P80	SDE-P100	SDE-P125	SDE-P150	SDE-P220
	With enclosure (With Ammeter)	SDA-P21	SDA-P35	SDA-P50	SDA-P60	SDA-P80	SDA-P100	SDA-P125	SDA-P150	SDA-P220
Rated Capacity (kW/HP)	200V~220V	11/ 15	19/ 25	22/ 30	30/ 40	37/ 50	45/ 60	55/ 75	75/ 100	110/ 150
	380V~440V	19/ 25	30/ 40	45/ 60	55/ 75	75/ 100	90/ 125	110/ 150	132/ 180	200/ 260
AC Magnetic Contactor	MCM	S-P21	S-P35T	S-P50T	S-P60T	S-P80T	S-P100T	S-P125T	S-P150T	S-P220T
	MCD	S-P21	S-P35T	S-P50T	S-P60T	S-P80T	S-P100T	S-P125T	S-P150T	S-P220T
	MCS	S-P11	S-P16	S-P21	S-P21	S-P35T	S-P35T	S-P50T	S-P50T	S-P60T
Thermal Overload Relay		TH-P20	TH-P60	TH-P60	TH-P120	TH-P120	TH-P120	TH-P220T	TH-P220T	TH-P400T
Conducting wire size of motor (mm ²)	Line side	2.5~16	2.5~25	2.5~35	2.5~50	10~70	10~95	35~150	35~150	35~240
	Load side	2.5~10	2.5~16	2.5~25	2.5~35	4~50	4~70	10~95	10~90	16~150
	Control side	1~2.5	1~2.5	1~2.5	1~2.5	1~2.5	1~2.5	1~2.5	1~2.5	1~2.5

Push Button | PB Series

Type	PB2	PB3
Contact schema		

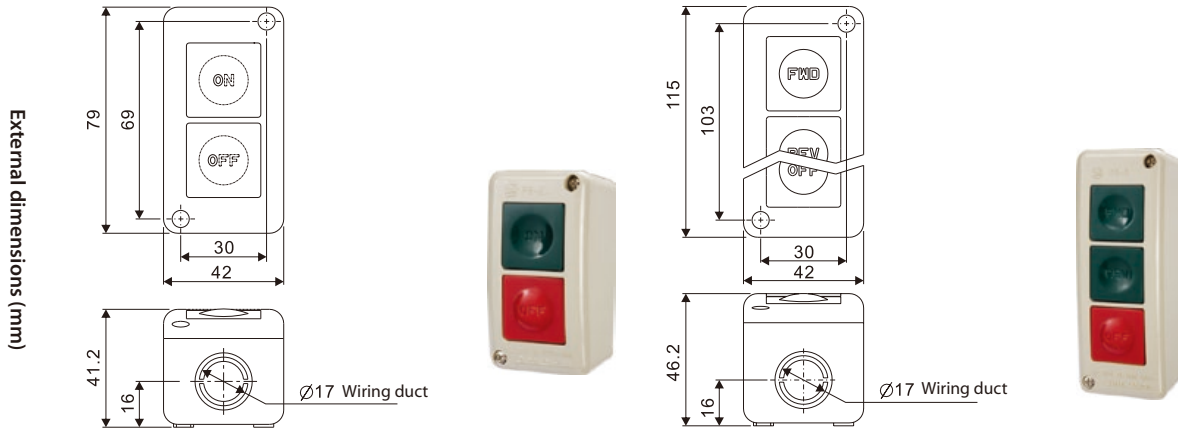

WET.

72.5g

110g

Separate Mounting Unit



Type	UATP12
TOR	TH-P12

Index

MCCB
ELCB

ATS

ACB

MCB

SPD

MS

MMS

BO

37

Auxiliary Contact Block

◆ AP Series



Installation		2P FRONT MOUNTED TYPE			4P FRONT MOUNTED TYPE			SIDE MOUNTED TYPE		
Model		AP-20	AP-11	AP-02	AP-40	AP-31	AP-22	APS-11	APL-11	
Contact		2NO	1NO 1NC	2NC	4NO	3NO 1NC	2NO 2NC	1NO 1NC	1NO 1NC	
Applicable contactor		SR-P40, SR-P50 S-P11~S-P80T SD-P11~SD-P21			SR-P40, SR-P50 S-P11~S-P80T SD-P11~SD-P21			SR-P40, SR-P50 S-P11~S-P60T SD-P11~SD-P21		
Rated Capacity AC 15 (A)	220V								1.6	
	380V								0.95	
Operation current (Ith) (A)									16	

Auxiliary Contact Block

◆ MAP Series

Installation		2P FRONT MOUNTED TYPE			4P FRONT MOUNTED TYPE				
Model		MAP-20	MAP-11	MAP-02	MAP-40	MAP-31	MAP-22		
Contact		2NO	1NO 1NC	2NC	4NO	3NO 1NC	2NO 2NC		
Applicable contactor		S-P06, S-P09.							
Rated Capacity AC 15 (A)	220V							3.3	
	380V							1.9	
Operation current (Ith) (A)								10	

Timer



Model		PTR-30		PTR-180			
Contact		1NO 1NC		1NO 1NC			
Applicable contactor		SR-P40, SR-P50, S-P11~S-P60T, SD-P11~SD-P21.					
Rated Capacity AC 15 (A)	220V					1.6	
	380V					0.95	
Operation current (Ith) (A)						16	

Surge unit



Model		BMSACW220V		BMSACW380V	
Applicable contactor		SR-P40, SR-P50, S-P11~S-P60T.			

Mechanical Interlock

Model		MPU-11		MPU-21		MPU-50	
Applicable contactor		S-P11/S-P15/S-P35T~60T		S-P12/S-P16~30T		S-P80T	

Characteristics

Model		S-P06 S-P09	S-P11 S-P15	S-P12	S-P16 S-P21 S-P25 S-P30T	S-P35T S-P40T	S-P50T S-P60T S-P80T	S-P100T	S-P125T S-P150T	S-P200T S-P220T	S-P300T S-P400T	M-600C
Coil Capacity (VA)	Impulse	25	55	55	55	72	250	319	370	440	700	4840
	Operation	5	11	11	11	12	28	36	42	50	50	242
Power Consumption (W)		1.6	2.5	2.5	2.5	3	7	11	10	12	7	80
Operation Vot. (Ue)	On	55~70%	55~68%	55~68%	59~70%	60~75%	63~75%	65~75%	75~80%	75~80%	65~80%	72~79%
	Off	35~50%	34~48%	34~48%	36~52%	40~57%	40~57%	40~55%	40~55%	40~60%	20~50%	59~66%
Close Time (ms)	Aux. OFF	5-12	5-12	4-11	6-14	6-13	6-13	18-28	9-20	10-19	22-37	42-71
	Aux. ON	6-15	10-18	10-18	10-18	12-20	12-20	22-32	15-24	17-25	25-40	49-78
	Contact ON	6-15	10-18	10-18	10-18	12-20	12-20	22-32	10-20	12-27	30-45	51-80
Open Time (ms)	Aux. OFF	6-15	12-20	9-18	9-19	10-17	10-17	50-100	9-18	10-20	40-60	61-97
	Aux. ON	5-12	8-15	4-13	6-14	5-12	5-12	48-98	7-15	7-18	31-51	58-94
	Contact ON	5-12	8-15	4-13	6-14	5-12	5-12	46-96	7-15	7-20	30-50	57-93

Coil Specifications Table

◆ S-P06~S-P25, S-P30T~P220T, SR-P40~P80, SC-P12~P60						
Description	AC12V	AC24V	AC48V	AC110V	AC120V	AC220V
Coil rated specifications marking	12V 50Hz 12V 60Hz	24V 50Hz 24V 60Hz	48~50V 50Hz 48~50V 60Hz	100V 50Hz 100~110V 60Hz	110~120V 50Hz 115~120V 60Hz	200~220V 50Hz 220V 60Hz
Description	AC230V	AC240V	AC380V	AC440V	AC480V	AC550V
Coil rated specifications marking	230V 50Hz 230V 60Hz	220~240V 50Hz 240~260V 60Hz	346~380V 50Hz 380V 60Hz	400V 50Hz 400~440V 60Hz	415~440V 50Hz 460~480V 60Hz	500V 50Hz 500~550V 60Hz

◆ S-P300T~P400T				
Description	AC48V	AC220V	AC380V	AC550V
Coil rated specifications marking	AC 48~50V 50/60Hz DC 48V	AC 100~240V 50/60Hz DC 100~220V	AC 265~450V 50/60Hz	AC 440~575V 50/60Hz

◆ M-600C					
Description	AC110V	AC120V	AC220V	AC230V	AC260V
Coil rated specifications marking	100V 50Hz 100~110V 60Hz	110~120V 50Hz 115~120V 60Hz	208~220V 50Hz 220V 60Hz	230~240V 50Hz 230~240V 60Hz	240~260V 50Hz 260~280V 60Hz
Description	AC380V	AC440V	AC480V	AC550V	
Coil rated specifications marking	346~380V 50Hz 380V 60Hz	380~415V 50Hz 400~440V 60Hz	415~440V 50Hz 460~480V 60Hz	500V 50Hz 500~550V 60Hz	

Index

MCCB
ELCB

ATS

ACB

MCB

SPD

MS

MMS

Selection Table ◆ Direct On-Line Starter

Motor rated capacity kW (HP)		3 φ 380V~440V		Selection of the contactor							
		Heating element rating (A)									
0.025	(1/30)	0.13A	0.1~0.16A	S-P06	S-P09						
0.04	(1/19)	0.2A	0.16~0.24A								
0.09	(1/8)	0.32A	0.24~0.4A								
0.18	(1/4)	0.5A	0.4~0.6A								
0.25	(1/3)	0.8A	0.6~1.0A								
0.37	(1/2)	1.3A	1.0~1.6A								
0.55	(3/4)	2.0A	1.6~2.4A								
0.75	(1)										
1.1	(1 1/2)	3.2A	2.4~4.0A								
1.5	(2)										
2.2	(3)	5A	4.0~6.0A								
3	(4)	7.5A	6.0~9.0A								
0.05	(1/15)	0.25A	0.19~0.31A	S-P11, S-P12	S-P15, S-P16						
0.1	(1/8)	0.4A	0.3~0.5A								
0.2	(1/4)	0.6A	0.45~0.75A								
0.3	(2/5)	0.9A	0.7~1.1A								
0.4	(1/2)	1.2A	0.9~1.5A								
0.75	(1)	1.7A	1.3~2.1A								
1.1	(1 1/2)	2.1A	1.6~2.6A								
1.5	(2)	3.3A	2.5~4.1A								
2.2	(3)	4.4A	3.4~5.4A								
3	(4)	6.5A	5~8A								
3.7	(5)			S-P21	S-P25						
4	(5 1/2)	9A	7~11A								
4.5	(6)					S-P30T	S-P35T				
5.5	(7 1/2)	11A	9~13A								
7.5	(10)	15A	12~18A								
11	(15)	21A	17~24A								
12	(16)							S-P40T	S-P50T		
15	(20)	28A	22~34A								
19	(25)	33A	28~38A								
22	(30)									S-P60T	S-P80T
25	(35)	40A	32~48A								
30	(40)	54A	43~65A								
37	(50)			S-P100T	S-P125T						
45	(60)	67A	54~80A								
50	(70)	80A	60~100A								
60	(80)					S-P150T	S-P200T				
75	(100)	105A	80~130A								
90	(125)	130A	100~160A								
110	(150)							S-P220T	S-P300T		
132	(180)	200A	150~250A								
150	(200)									S-P400T	M-600C
160	(220)	260A	200~320A								
160	(220)										
220	(330)	350A	260~440A								
250	(350)										
315	(420)	500A	400~600A								

Motor Starter

Index
MCCB ELCB
ATS
ACB
MCB
SPD
MS
MMS

Selection Table ◆ Direct On-Line Starter

Motor rated capacity kW (HP)		3 φ 500V~550V										
		Heating element rating (A)		Selection of the contactor								
0.06	(1/12)	0.13A	0.1~0.16A	S-P06	S-P09							
0.09	(1/8)	0.2A	0.16~0.24A									
0.12	(1/6)	0.32A	0.24~0.4A									
0.18	(1/4)	0.5A	0.4~0.6A									
0.37	(1/2)	0.8A	0.6~1.0A									
0.55	(3/4)	1.3A	1.0~1.6A									
0.75	(1)	2.0A	1.6~2.4A									
1.1	(1 1/2)											
1.5	(2)	3.2A	2.4~4.0A									
2.2	(3)											
3	(4)	5A	4.0~6.0A									
4	(5 1/2)	7.5A	6.0~9.0A									
0.12	(1/6)	0.25A	0.19~0.31A	S-P11, S-P12	S-P15, S-P16	S-P21	S-P25	S-P30T	S-P35T	S-P40T		
0.18	(1/4)	0.4A	0.3~0.5A									
0.25	(1/3)	0.6A	0.45~0.75A									
0.37	(1/2)	0.9A	0.7~1.1A									
0.55	(3/4)	1.2A	0.9~1.5A									
0.75	(1)	1.7A	1.3~2.1A									
1.1	(1 1/2)	2.1A	1.6~2.6A									
1.5	(2)	3.3A	2.5~4.1A									
2.2	(3)	4.4A	3.4~5.4A									
4	(5 1/2)	6.5A	5~8A									
4.5	(6)	9A	7~11A									
5.5	(7 1/2)	11A	9~13A									
7.5	(10)	15A	12~18A									
11	(15)	21A	17~24A									
12	(16)											
15	(20)	28A	22~34A									
19	(25)	33A	28~38A									
22	(30)	40A	32~48A									
30	(40)	54A	43~65A									
37	(50)											
45	(60)	67A	54~80A									
50	(70)											
60	(80)	80A	60~100A									
75	(100)	105A	80~130A									
90	(125)	130A	100~160A									
110	(150)	160A	120~200A									
132	(180)											
150	(200)	200A	150~250A									
160	(220)	260A	200~320A									
220	(330)	350A	260~440A									
315	(420)	500A	400~600A									

Index

MCCB
ELCB

ATS

ACB

MCB

SPD

MS

MMS

Selection Table ◆ λ - Δ Starter

Heater selection table (A)	Motor output kW (HP)				TH selection of λ - Δ Starter																	
	A		B		21		35		50		60		80		100		125		150		220	
	200~220V		380~440V		A	B	A	B	A	B	A	B	A	B	A	B	A	B	A	B	A	B
6.5	1.5	(2)	3	(4)	TH-P20	TH-P20																
9	1.9	(2 1/2)	3.7	(5)																		
9	2.2	(3)	4.5	(6)																		
11	3	(4)	5.5	(7 1/2)																		
15	3.7	(5)	7.5	(10)																		
15	4.5	(6)	10	(13)																		
21	5.5	(7 1/2)	11	(15)	TH-P20TA	TH-P20TA																
28	6.5	(8)	14	(19)																		
28	7.5	(10)	15	(20)																		
33	9	(12 1/2)	19	(25)	TH-P60	TH-P60	TH-P60	TH-P60	TH-P60TA	TH-P60TA												
40	11	(15)	22	(30)																		
40	14	(19)	26	(35)																		
54	15	(20)	30	(40)																		
67	19	(25)	37	(50)																		
80	22	(30)	45	(60)																		
80	25	(34)	50	(67)	TH-P120	TH-P120	TH-P120	TH-P120	TH-P120TA	TH-P120TA												
105	30	(40)	55	(75)																		
130	37	(50)	75	(100)																		
160	45	(60)	90	(125)	TH-P220T	TH-P220T	TH-P220T	TH-P220T	TH-P220T	TH-P220T												
200	55	(75)	110	(150)																		
200	65	(85)	132	(200)																		
260	75	(100)	150	(200)	TH-P400T	TH-P400T																
350	110	(150)	200	(260)																		

Motor Starter

Index

MCCB
ELCB

ATS

ACB

MCB

SPD

MS

MMS

MANUAL MOTOR STARTER

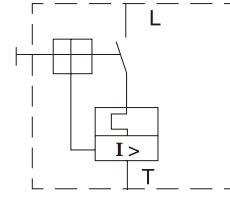
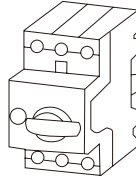

Power factor AC-3 400V (kW)	Rated current In (A)	Overload adjustable range In (A)	Tripping current (A) Id ± 20%	Type	
				Button	Rotary
—	0.16	0.1-0.16	1.92	MR-32S-0.16	MR-32R-0.16
—	0.25	0.16-0.25	3	MR-32S-0.25	MR-32R-0.25
—	0.4	0.25-0.4	4.8	MR-32S-0.4	MR-32R-0.4
—	0.63	0.4-0.63	7.56	MR-32S-0.63	MR-32R-0.63
—	1	0.63-1	12	MR-32S-1	MR-32R-1
0.37	1.6	1-1.6	19.2	MR-32S-1.6	MR-32R-1.6
0.75	2.5	1.6-2.5	30	MR-32S-2.5	MR-32R-2.5
1.5	4	2.5-4	48	MR-32S-4	MR-32R-4
2.2	6.3	4-6.3	75.6	MR-32S-6.3	MR-32R-6.3
4	10	6-10	120	MR-32S-10	MR-32R-10
5.5	14	9-14	168	MR-32S-14	MR-32R-14
7.5	18	13-18	216	MR-32S-18	MR-32R-18
11	23	17-23	276	MR-32S-23	MR-32R-23
11	25	20-25	300	MR-32S-25	MR-32R-25
15	32	24-32	384	MR-32S-32	MR-32R-32

Side AX (MR-AN)

Front AX (MR-AE)

SHT (MR-AS)



AL (MR-AM)

UVT (MR-AU)



MMS



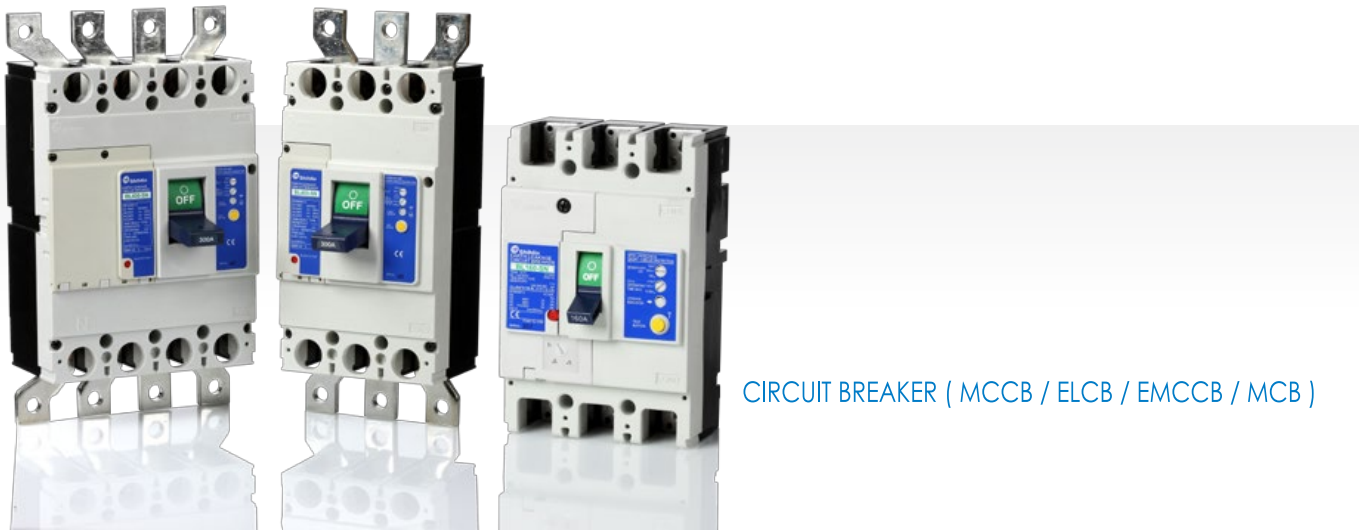

CIRCUIT BREAKER (MCCB / ELCB / EMCCB / MCB)

Breaker & Switchgear System



AIR CIRCUIT BREAKER

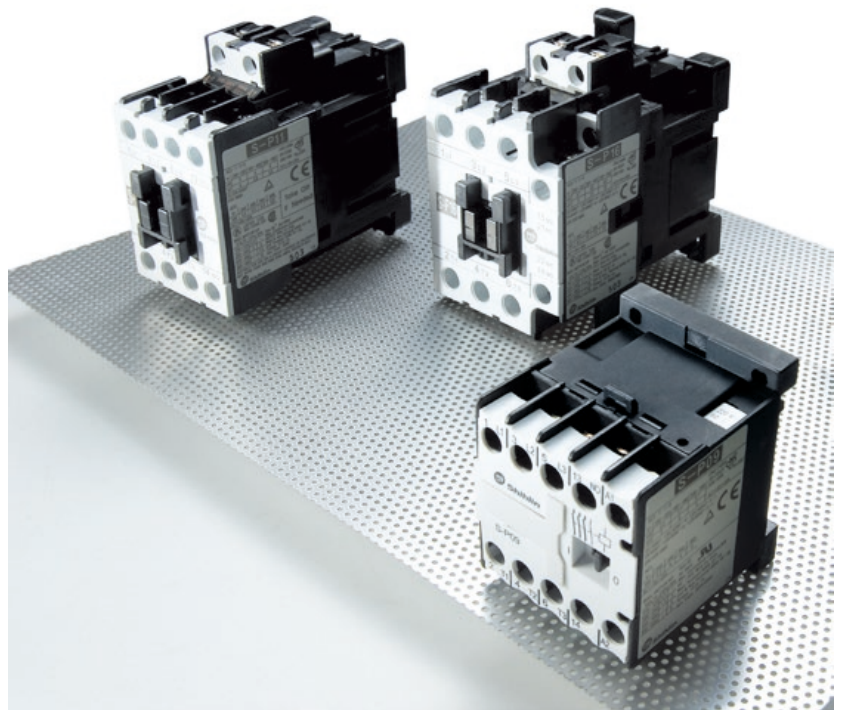

MAGNETIC CONTACTOR / SWITCH (CONTACTOR / MS / MMS)



AUTOMATIC TRANSFER SWITCHES



SURGE PROTECTIVE DEVICE



SMART METER



INVERTER



LOW VOLTAGE POWER CAPACITORS

SHIHLIN ELECTRIC & ENGINEERING

MAGNETIC CONTACTOR / SWITCH (CONTACTOR/ MS/ MMS), CIRCUIT BREAKER (MCCB/ ELCB/ EMCCB/ MCB), AIR CIRCUIT BREAKER, AUTOMATIC TRANSFER SWITCHES, SURGE PROTECTIVE DEVICE, SMART METER, LOW VOLTAGE POWER CAPACITORS, INVERTER



Breaker & switchgears overseas sales dept.

3F, No.9, Sec. 1, Chang-an E. Rd., Zhongshan Dist., Taipei City 10441, Taiwan

T. +886-2-2541-9822 F. +886-2-2581-2665

e-mail. b.export@seec.com.tw

<http://circuit-breaker.seec.com.tw>

Headquarters

16F, No.88, Sec. 6, Zhongshan N. Rd., Shilin Dist., Taipei City 11155, Taiwan

T. +886-2-2834-2662 F. +886-2-2836-6187

<http://www.seec.com.tw>

Distributor

B151222E.ALL-OB